



Production Catalogue

plast|port  
by KAPP



*Mutfağın tüm renkleri...*

*All colours of the kitchen...*

# KAPP ÜRETİM TESİSLERİ MANUFACTURING FACILITIES





# İçindekiler / Index



- 08 | **Düdüklü Tencere** / Pressure Cooker
- 13 | **Silindirik Tencereler** / Stock Pots Casseroles
- 15 | **Kapaklar** / Lids
- 16 | **Piştirme Süzgeçler** / Cooking Colanders
- 18 | **Helvane Tencereler** / Wide Shallow Pots
- 19 | **Fırın Tepsiler** / Roasting Pans



- 21 | **Tek Saplı Tavalar** / Fry Pans
- 21 | **Derin Tava** / Saute Pan
- 21 | **Çift Saplı Tava** / Paella Pan
- 21 | **Sahan** / French Omelette Pan
- 23 | **Kaçarolalar** / Sauce Pans
- 23 | **Sote Tavalar** / Conical Saute Pans



- 24 | **Mayonez Kabı** / Mixing Bowl
- 24 | **Süzgeçler** / Colanders
- 25 | **Standlar** / Stands
- 25 | **Şampanya Kovası** / Champagne-Wine Bucket



- 25/29 | **Gastronorm Küvetler** / GN Food Pans
- 30/31 | **Süzgeçli GN Küvetler** / Perforated GN Food Pans
- 32/33 | **Saplı GN Küvetler** / GN Food Pans w/ handle
- 34 | **Gastronorm Kapaklar** / GN Food Pan's Lids
- 35 | **Küvetler** / Food Pans
- 36 | **Bain Marie Küvetler** / Bain Marie Containers



- 35 | **Tepsiler** / Trays
- 36/51 | **Titan Chafing Dish**
- 36/51 | **Titan Chafing Dish Rezistanslı** / Titan Chafing Dish w/Heated Lid
- 42 | **İndüksiyon Isıtıcı** / Induction Heating



- 52 | **Taşıma Kovaları** / Carrying Containers
- 53 | **Sefer Taşları** / Portable Food Containers
- 55 | **Servis Arabaları** / Service Trolleys
- 56 | **Taşıma Arabaları** / Carrying Trolleys
- 57 | **Bulaşık Yıkama** / Dish Washing

# İçindekiler / Index



- 60/61 | **Elektrikli / Electrical Thermobox**  
63/65 | **Thermobox / Thermobox**  
66/67 | **Sebze Kurutucu / Salad Spinner**



- 60/61 | **PC Gastronorm Kuvetler / PC GN Pans**  
63/65 | **PC Gastronorm Kapaklar / PC GN Food Pan's Lids**  
66/67 | **PP GN Saklama Kapları / PP GN Food Containers**



- 76/77 | **Self Servisler / Self Services**  
79 | **Servis Tepsiler / Serving Trays**  
81/87 | **PC Bardaklar / PC Glasses**

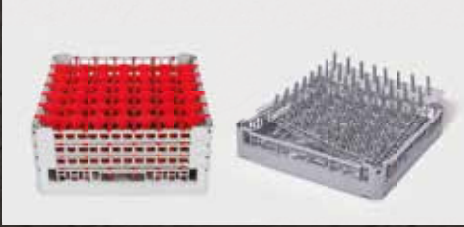

- 89 | **Tabak Basketi / Plate/Tray Racks**  
89 | **Çatal Kaşık Basketi / Cutlery Rack**  
90/91 | **Bardak Basketi / Glass Rack**  
90/91 | **Yükselticiler / Extenders**  
94/95 | **Seperatörler / Seperators**



- 89 | **Servis Arabaları / Servis Trolleys**  
89 | **Erzak Arabası / Ingredient Bin**  
90/91 | **PP Hamur Teknesi / PP Dough Tray**  
90/91 | **Dispenserler/ Dispensers**



- 99/100 | **PC Tabaklar / PC Plates**  
101 | **PC Sosluklar / PC Sauce Cups**  
102 | **PC Servis Ekipmanları / PC Serving Tools**  
103 | **Rotil Ayaklar / Rotil Feet**







## Düdüklü Tencere / Pressure Cooker

Güvenlik Valfi / Security Valve  
2 aşamalı güvenlik valfi  
ekstra güvenli kullanım sağlar  
2 independent safety valve system  
provides extra safe usage



Basınç Valfi / Pressure Valve  
3 kademeli buhar boşaltımı sağlar  
3 positioning for blowoff



08

### » Düdüklü Tencere / Pressure Cooker

Kod Code	Øxh (cm) Øxh (cm)	Lt Lt	Koli/Adet Pcs/Ctn
32383219	32x19	15	1
32383223	32x23	18	1
32383230	32x30	23	1

Kod Code	Øxh (cm) Øxh (cm)	Ø (cm) Ø (cm)	Koli/Adet Pcs/Ctn
35700032	Düdüklü Tencere Kapak / Pressure Cooker Lid	32	1
30210132	Konvex Kapak / Convex Lid	32	1
35700154	Silikon Kapak Contası / Silicone Seal	32	2



- 1,20 mm kalınlığında 304 kalite paslanmaz çelikten imal edilmiştir
- 2 adet emniyet valfi mevcuttur; 1. valf açılmadığı takdirde, 2. valf devreye girer
- Buhar boşaltma valfi 3 konumdan oluşur: 1. ve 2. konum pişirmede, 3. konum buhar boşaltmada kullanılır
- Kolay kilitlenebilir inovatif kapak
- Impact Bonded sandviç taban
- Hızlı ve verimli ısı dağıtımı
- Isıya dayanıklı saplar
- Kapak parçaları sökülüp takılabilir ve yıkanabilir
- İndüksiyon ocaklara uygundur

- 18/10 Stainless Steel, 1,20 mm thickness
- 2 Independent Safety Valves for Security ; second valve is activated when the first valve is not opened,
- Blowoff valve consists of 3 positions: 1. and 2. position is for cooking, 3. position is for blowoff
- Innovative Lid with Easy to Use Locking System
- Impact Bonded Sandwich Bottom
- Fast and Efficient Heat Distribution
- Heat Resistant Side Handles
- Easy Cleaning With Removable Lid Attachments
- Induction ready





- KAPP stands out with “IMPACT BONDED” three layer sandwich bottom in all lines and sizes.
- KAPP is the only brand which offers “induction ready” cookware in ALL sizes.

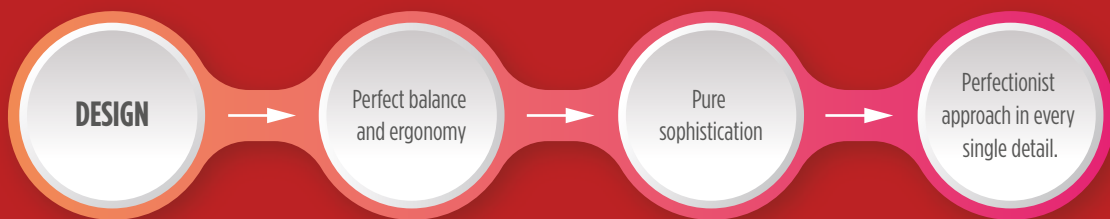

## QUALITY

KAPP products are extremely robust. Tried and tested up to the highest standards. By leveraging our strengths in product design, packaging and distribution; we provide unique, innovative solutions for Professional Kitchens

.KAPP products are manufactured by means of attentive production processes and only delivered after strict quality controls.

All the procedures are monitored by our Quality Management System which is certified by TUV, GOST, HACCP and CE internationally.

“The Great Lake Culinary Institute Laboratories” in USA, tested and approved our quality and classified KAPP products within the best quality product ranges in the world.

## TEKNOLOJİ VE KALİTE GELENEĞİ



Paslanmaz Çelik /Stainless Steel  
Alüminyum /Aluminum  
Paslanmaz Çelik /Stainless Steel

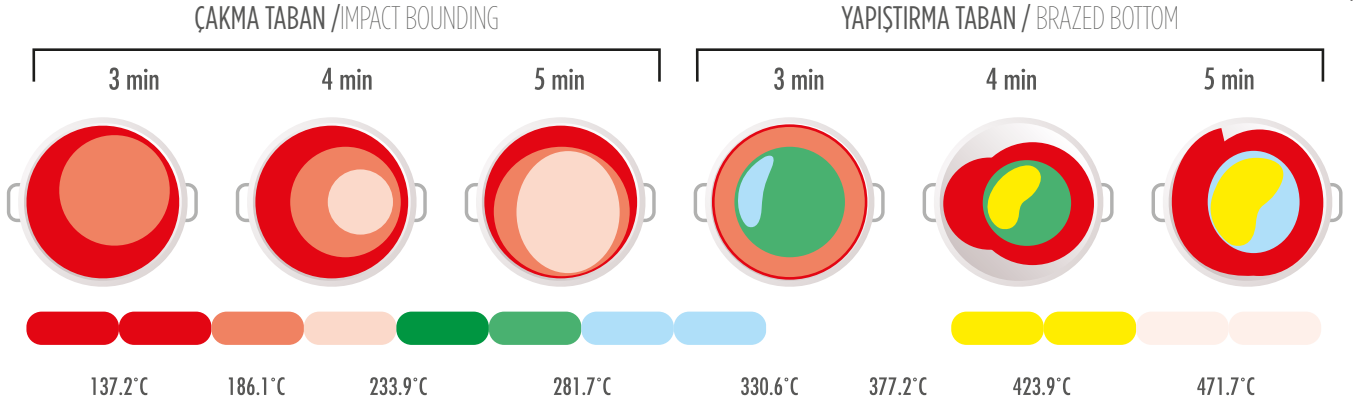
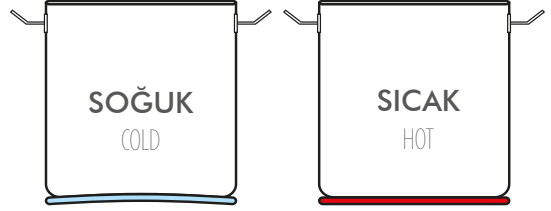

\* Tencere tabanı 2500 ton üzerinde Kuvvetle çakılmaktadır.

/ Bases are forged bound by over 2500 tons pressure

\* %95 oranında saf alüminyum

/ %95 pure aluminum

\* Taban saclarında %99 üzerinde birleşme

/ Bottom plates combine chemically over %99

\* Yapışma makinesiyle birleştirme

/ Combine with brazing machine

\*Normal, saf olmayan alüminyum

/ Standart aluminum, not pure

\*3. Katın %55 oranında birleşmesi

/ %55 combining of the 3. Layer



Mükemmel eşit pişirme  
Perfect even cooking



Yapışma, yanma ihtimali Değişken ısı  
Sticking, burning possibility Variable heat



Yapışma, yanma Yüksek ısı  
Sticking, burning High heat

- Ekstra puntalarla güçlendirilmiş saplar dayanıklılığı artırır, en büyük boy tencereler de dahil ağırlıktan kaynaklı bükülme yaşanmaz.

*Handles are reinforced with extra durability, there is no weight-induced bending, even in the largest pots.*



- Her tencerenin sapında üretildiği tarih yazılıdır. Ürünlerin kalite kontrolü ve takibi mutfaklara girdikten sonra da devam eder. Her tencere 5 yıl garantiye sahiptir.

*Each pot has its production date on its handles. Quality control and follow-up of the products continue after entering the kitchens. Each pot has a 5 year warranty.*



**ENERGY SAVER  
IMPACT BONDING**

- "Impact" taban teknolojisiyle her ürünün tabanı 5 yıl süreyle Kapp garantisi altındadır.

*Every product with "Impact" base technology has under Kapp's guarantee for 5 years.*



## Silindirik Tencereler / Stock Pots Casseroles



### » Derin (Kapaklı) / Jumbo Stockpot (w/lid)

Kod Code	Øxh (cm) Øxh (cm)	Lt Lt	Koli/Adet Pcs/Ctn
30141616	16x16	3,0	4
30142020	20x20	6,3	4
30142424	24x24	10,5	2
30142828	28x28	17,2	2
30143030	30x30	21,2	1
30143231	32x32	26,0	1
30143635	36x36	36,6	1
30144040	40x40	50,0	1
30144544	45x45	70,0	1
30145050	50x50	100	1
30146055	60x55	155,4	1

### » Orta Derin (Kapaklı) / Stockpot (w/Lid)

Kod Code	Øxh (cm) Øxh (cm)	Lt Lt	Koli/Adet Pcs/Ctn
30142017	20x17	5,3	4
30142419	24x19,5	8,8	4
30142823	28x23	14,2	2
30143024	30x24	17,0	2
30143227	32x27,5	22,1	2
30143629	36x29	29,5	1
30144032	40x32	40,2	1
30144528	45x28	44,0	1
30145030	50x30	58,0	1
30146035	60x35	99,0	1

### » Orta (Kapaklı) / Deep Casseroles (w/Lid)

Kod Code	Øxh (cm) Øxh (cm)	Lt Lt	Koli/Adet Pcs/Ctn
30141611	16x11	2,0	4
30141812	18x12	3,0	4
30142013	20x13	4,1	4
30142214	22x14	5,3	4
30142415	24x15	6,8	4
30142817	28x17	10,5	2
30143020	30x20	14,1	2
30143219	32x19	15,3	2
30143622	36x22	22,4	2
30144025	40x25	32,0	1
30144522	45x22	35,0	1
30146025	60x25	70,0	1

13



### » Orta Sığ (Kapaklı) / Shallow Casseroles (w/Lid)

Kod Code	Øxh (cm) Øxh (cm)	Lt Lt	Koli/Adet Pcs/Ctn
30141608	16x7	1,4	4
30141809	18x8	2,0	4
30142010	20x9	3,0	4
30142210	22x9,5	3,6	4
30142411	24x10,5	5,0	4
30142812	28x12	7,4	4
30143012	30x12	8,4	2
30143215	32x15	12,1	2
30143617	36x17	17,3	2
30144019	40x19	25,0	1
30145020	50x20	39,0	1

### » Sığ Tencere (Kapaklı)

Shallow Casseroles (w/lid)

Kod Code	Øxh (cm) Øxh (cm)	Lt Lt	Koli/Adet Pcs/Ctn
30142475	24x7,5	3,5	4
30142807	28x7	4,3	4
30143275	32x7,5	6,0	2
30143608	36x8	8,1	2
30144008	40x8	10,0	2
30144510	45x10	15,9	1
30145010	50x10	20,0	1
30146010	60x10	28,3	1



## Silindirik Tencereler / Stock Pots Casseroles



### » Derin Tencere

Jumbo Stock Pot

Kod Code	Øxh (cm) Øxh (cm)	Lt Lt	Koli/Adet Pcs/Ctn
30311616	16x16	3,0	4
30312020	20x20	6,3	4
30312424	24x24	10,5	2
30312828	28x28	17,2	2
30313030	30x30	21,2	1
30313231	32x32	26,0	1
30313635	36x36	36,6	1
30314038	40x40	50,0	1
30314544	45x45	70,0	1
30315050	50x50	100,0	1
30316055	60x55	155,4	1

### » Orta Derin Tencere

Stock Pot

Kod Code	Øxh (cm) Øxh (cm)	Lt Lt	Koli/Adet Pcs/Ctn
30312017	20x17	5,3	4
30312419	24x19,5	8,8	4
30312823	28x23	14,2	2
30313024	30x24	17,0	2
30313228	32x27,5	22,1	2
30313629	36x29	29,5	1
30314032	40x32	40,0	1
30314528	45x28	44,0	1
30315030	50x30	58,0	1
30316035	60x35	99,0	1

### » Orta Boy Tencere

Deep Casseroles

Kod Code	Øxh (cm) Øxh (cm)	Lt Lt	Koli/Adet Pcs/Ctn
30311611	16x11	2,0	4
30311812	18x12	3,0	4
30312013	20x13	4,1	4
30312214	22x14	5,3	4
30312415	24x15	6,8	4
30312817	28x17	10,5	2
30313020	30x20	14,1	2
30313219	32x19	15,3	2
30313622	36x22	22,4	1
30314025	40x25	32,0	1
30314522	45x22	35,0	1
30316025	60x25	70,0	1

14



### » Orta Sığ Tencere

Shallow Casseroles

Kod Code	Øxh (cm) Øxh (cm)	Lt Lt	Koli/Adet Pcs/Ctn
30311607	16x7	1,4	4
30311808	18x8	2,0	4
30312009	20x9	3,0	4
30312210	22x9,5	3,6	4
30312411	24x10,5	4,7	4
30312812	28x12	7,4	4
30313015	30x12	8,4	2
30313215	32x15	12,1	2
30313617	36x17	17,3	2
30314019	40x19	25,0	1
30315019	50x20	39,3	1



### » Sığ Tencere

Shallow Stew Pan

Kod Code	Øxh (cm) Øxh (cm)	Lt Lt	Koli/Adet Pcs/Ctn
30312475	24x7,5	3,5	4
30312807	28x7	4,3	4
30313208	32x7,5	6,0	2
30313608	36x8	8,1	2
30314008	40x8	10,0	2
30314510	45x10	15,9	1
30315010	50x10	20,0	1
30316010	60x10	28,3	1





## » Kapaklar

Lids

Kod Code	Ø (cm) Ø (cm)	Koli/Adet Pcs/Ctn
30212116	16	4
30212118	18	4
30212120	20	4
30212122	22	4
30212124	24	4
30212128	28	2
30212132	32	2
30212136	36	2
30212140	40	1
30212145	45	1
30212150	50	1
30212160	60	1



## » Konvex Kapaklar

Convex Lids

Kod Code	Ø (cm) Ø (cm)	Koli/Adet Pcs/Ctn
30210116	16	4
30210118	18	4
30210120	20	4
30210122	22	4
30210124	24	4
30210128	28	2
30210130	30	2
30210132	32	2
30210136	36	2
30210140	40	1
30210145	45	1
30210150	50	1
30210160	60	1

15

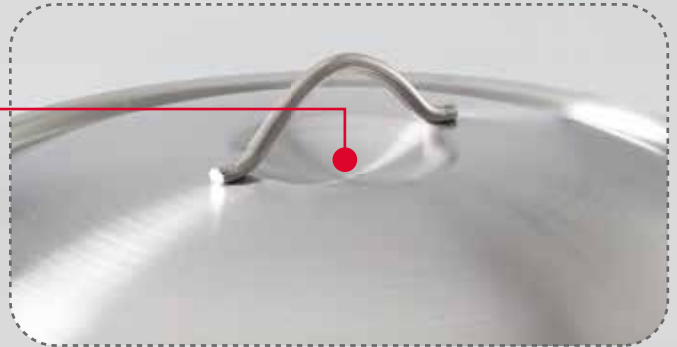
**Küçük detaylar büyük farklar yaratır**

Kapak ve sap arasındaki ekstra boşluk sıcak kapağa temas etmeden tutma kolaylığı sağlar.  
Güvenli bir pişirme deneyimi yaratır.

**Small details make big differences**

The extra space between the handle and the lid allows the chef's hands to fit comfortably without touching the hot lid.  
Creating a safer cooking experience.





## Piřirme Süzgeçleri / Cooking Colanders



» Makarna Piřirme Süzgeci  
Pasta Colander

Kod Code	Özellik Description	Koli/Adet Pcs/Ctn
36302420	24x19,5 Tencere ile uyumludur / Suitable for 24x19,5 Pot	3
36303623	36x22 Tencere ile uyumludur / Suitable for 36x22 Pot	4
36304026	40x25 Tencere ile uyumludur / Suitable for 40x25 Pot	4



» Makarna Piřirme Süzgeci Seti  
Pasta Colander Set

Kod Code	Øxh (cm) Øxh (cm)	Lt Lt	Koli/Adet Pcs/Ctn
36312420	24x19,5 (3 Süzgeçli/ 3 Colanders)	8,8	1
36313623	36x22 (4 Süzgeçli/4 Colanders)	22,4	1
36314026	40x25 (4 Süzgeçli/4 Colanders)	32,0	1

\* Fiyatlara kapak dahildir. / Lid is included in price





» Kuskus Tencere Süzgeci  
Couscous Colander

Kod Code	Øxh (cm) Øxh (cm)	Koli/Adet Pcs/Ctn
35664032	40x24	1
35665040	50x24	1
35666045	60x24	1

» Kuskus Tencere Seti (Kapaklı)  
Couscous Set (w/lid)

Kod Code	Øxh (cm) Øxh (cm)	Lt Lt	Koli/Adet Pcs/Ctn
35614032	A 40x24 B 32x32	30	1
35615040	A 50x24 B 40x40	47	1
35616040	A 60x24 B 40x40	65	1
35616045	A 60x24 B 45x45	65	1
35616050	A 60x24 B 50x50	65	1



» Çorbalık (Gömme)  
Soup Pot (Built-in)

Kod Code	Øxh (cm) Øxh (cm)	Lt Lt	Koli/Adet Pcs/Ctn
35522428	24x28 (Tabanlı/w/base)	12,5	2
35522828	28x28 (Tabanlı/w/base)	17,2	2
35523232	32x32 (Tabanlı/w/base)	26,0	1
35503637	36x36 (Tabanlı/w/base)	36,6	1
35504050	40x40 (Tabanlı/w/base)	50,0	1
35505051	50x50 (Tabanlı/w/base)	100	1
35506055	60x55 (Tabanlı/w/base)	155,4	1
35522400	24x28 (Tabansız/w/o base)	12,5	2
35522800	28x28 (Tabansız/w/o base)	17,2	2
35523200	32x32 (Tabansız/w/o base)	26,0	1
35503600	36x36 (Tabansız/w/o base)	36,6	1
35504000	40x40 (Tabansız/w/o base)	50,0	1
35505000	50x50 (Tabansız/w/o base)	100	1
35506000	60x55 (Tabansız/w/o base)	155,4	1

## Helvane Tencereler / Wide Shallow Pots

### » Tencereler (Kapaklı)

Wide Shallow Pots

Kod Code	Øxh (cm) Øxh (cm)	Lt Lt	Koli/Adet Pcs/Ctn
30013015	30x15	13	4
30013615	36x15	16	4
30013620	36x20	21	4
30014017	40x17	24	3
30014520	45x20	29	2
30015020	50x20	36	2
30015520	55x20	40	2
30016020	60x20	45	2
30016025	60x25	65	1
30016525	65x25	75	1
30017030	70x30	108	1
30018030	80x30	136	1
30019030	90x30	166	1
30010035	100x35	258	1
30011035	110x35	289	1



18

### » Helvane Kapaklar

Lids

Kod Code	Ø (cm) Ø (cm)	Koli/Adet Pcs/Ctn
30210300	30	2
30210360	36	2
30210400	40	2
30210450	45	2
30210500	50	2
30210550	55	2
30210600	60	2
30210650	65	1
30210700	70	1
30210800	80	1
30210900	90	1
30210100	100	1
30210110	110	1

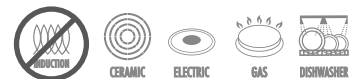



» Kapaklı Fırın Tepsisi  
Roasting Pan w/Clip-on Cover

Kod Code	Ölçü Dims. (cm)	Koli/Adet Pcs/Ctn
30714565	40x60x5	2
30714568	40x60x8	2
30714561	40x60x10	2
30715355	50x35x5	2
30715358	50x35x8	2
30715310	50x35x10	2
30715705	50x70x5	2
30715708	50x70x8	2
30715710	50x70x10	2



» Yuvarlak Fırın Tepsisi  
Round Roasting Pan (S / S)

Kod Code	Øxh (cm) Øxh (cm)	Koli/Adet Pcs/Ctn
30703805	36x5	4
30704505	45x5	4
30705005	50x5	2
30706005	60x5	2



» Kapaksız Fırın Tepsisi  
Roasting Pan without Lid

Kod Code	Ölçü Dims. (cm)	Koli/Adet Pcs/Ctn
30704565	40x60x5	2
30704568	40x60x8	2
30704561	40x60x10	2
30705355	50x35x5	2
30705358	50x35x8	2
30705310	50x35x10	2
30705705	50x70x5	3
30705708	50x70x8	3
30705710	50x70x10	3



» Kapak  
Cover

Kod Code	Ölçü Dims. (cm)	Koli/Adet Pcs/Ctn
30705711	40x60	1
30705713	50x35	1
30705712	50x70	1

## Paslanmaz Çelik Tavalar

- Paslanmaz çelik gövde
- Profesyonel kullanıma uygun ısıya dayanıklı paslanmaz çelik saplar
- Impact teknolojisi ile imal edilmiş 3 kat sandviç taban
- Her kullanıma uygun ölçü seçenekleri
- Mükemmel ısı dağılımı
- Saten yüzey
- İndüksiyon ocaklara uygundur

## Stainless Steel Pans

- Stainless steel 18/10 body
- Heat resistant stainless steel professional handles
- Impact bonded sandwich bottom
- Multiple size options for various cooking
- Even heat distribution
- Satin finishing
- Suitable for induction cookers





» Tek Saplı Tava  
Fry Pan

Kod Code	Øxh (cm) Øxh (cm)	Lt Lt	Koli/Adet Pcs/Ctn
30152004	20x5	1,6	4
30152405	24x5,5	2,5	4
30152806	28x6	3,7	4
30153206	32x7	6,0	1
30153606	36x7	8,1	1
30154007	40x8	10,1	1

\* Ø32, Ø36, Ø40 Destek sap ilavedir  
\* Ø32, Ø36, Ø40 w/helper handle

» Tek Saplı Yapışmaz Çelik Tava  
Non-Stick Coated Fry Pan

Kod Code	Øxh (cm) Øxh (cm)	Lt Lt	Koli/Adet Pcs/Ctn
30342004	20x5	1,6	4
30342405	24x5,5	2,5	4
30342805	28x6	3,7	4
30343207	32x7	6,0	1
30343608	36x7	8,1	1
30344008	40x8	10,1	1

\* Ø32, Ø36, Ø40 Destek sap ilavedir  
\* Ø32, Ø36, Ø40 w/helper handle

\* İndüksiyon ocaklarda kullanılmaz.  
\* Not suitable for induction



» Derin Tava (Balık Tava)  
Saute Pan

Kod Code	Øxh (cm) Øxh (cm)	Lt Lt	Koli/Adet Pcs/Ctn
30452004	20x5	1,6	4
30452405	24x5,5	2,5	4
30452805	28x8	3,7	4
30453207	32x7,5	6,0	2
30453606	36x8	8,1	1

21



» Çift Saplı Tava (Paella)  
Paella Pan

Kod Code	Øxh (cm) Øxh (cm)	Lt Lt	Koli/Adet Pcs/Ctn
30362004	20x5	1,6	4
30362405	24x5,5	2,5	4
30362806	28x6	3,7	2
30363207	32x6,5	6,0	2
30363608	36x7,5	8,1	2
30364008	40x8	10,1	2



» Sahan  
French Omelette Pan

Kod Code	Øxh (cm) Øxh (cm)	Koli/Adet Pcs/Ctn
30315014	14x3	10
30315016	16x3	10
30315018	18x3	8
30315020	20x3	8
30315022	22x3	6
30315024	24x3	6
30315028	28x3	2
30315032	32x3	2



» Helvane Tava  
Wide Shallow Pan w/o Lid

Kod Code	Øxh (cm) Øxh (cm)	Lt Lt	Koli/Adet Pcs/Ctn
30323008	30x8	5,0	3
30323609	36x9	9,0	3
30324012	40x12	15,7	2
30324512	45x12	19,0	2
30325012	50x12	23,0	2
30326014	60x14	34,0	1
30327015	70x14	53,5	1
30328016	80x16	73,0	1

\* İndüksiyon ocaklarda kullanılmaz.  
\* Not suitable for induction







» Derin Kaçarola  
Deep Sauce Pan

Kod Code	Øxh (cm) Øxh (cm)	Lt Lt	Koli/Adet Pcs/Ctn
30150008	16x11	2,2	6
30150004	18x12	3,1	4
30150005	20x13	4,1	4
30150019	22x14	5,3	2
30150006	24x15	6,8	2
30150020	28x17	10,5	2
30150021	30x12	8,5	2
30150030	32x15	12,1	2

\*Ø28, Ø30, Ø32 Destek sap ilavedir  
\*Ø28, Ø30, Ø32 w/helper handle support



» Sığ Kaçarola  
Shallow Sauce Pan

Kod Code	Øxh (cm) Øxh (cm)	Lt Lt	Koli/Adet Pcs/Ctn
30150007	12x6	0,7	6
30150010	14x7	1,1	6
30150015	16x7	1,4	6
30150018	18x8	2,0	4
30150017	20x9	2,8	4
30150016	22x9,5	3,6	2
30150014	24x10,5	4,7	2



» Tabansız Kaçarola  
Sauce Pan without Sandwich Bottom

Kod Code	Øxh (cm) Øxh (cm)	Lt Lt	Koli/Adet Pcs/Ctn
30381206	12x6	0,7	6
30381407	14x7	1,1	6
30381607	16x7	1,4	6
30381611	16x11	2,2	6
30381809	18x8	2,0	4
30381812	18x12	3,1	4
30382010	20x9	3,2	4
30382013	20x13	4,1	4
30382411	24x10,5	5,0	2
30382415	24x15	6,8	2
30382814	28x14	7,6	2

\* Pişirme amaçlı kullanılmaz.  
\* Not suitable for cooking

23



» Yapışmaz Sote Tava  
Non-stick Coated Conical Saute Pan

Kod Code	Øxh (cm) Øxh (cm)	Lt Lt	Koli/Adet Pcs/Ctn
30331605	16x6	0,75	4
30331805	18x6,5	1,0	4
30332005	20x7	1,9	2
30332405	24x8	2,5	2

\* İndüksiyon ocaklarda kullanılmaz.  
\* Not suitable for induction



» Sote Tava  
Conical Saute Pan

Kod Code	Øxh (cm) Øxh (cm)	Lt Lt	Koli/Adet Pcs/Ctn
30431606	16x6	0,75	4
30431806	18x6,5	1,0	4
30432006	20x7	1,9	2
30432406	24x8	2,5	2

» Sote Tava (Çift Dökme Ağızlı)  
Conical Saute Pan w/Double Spouts

Kod Code	Øxh (cm) Øxh (cm)	Lt Lt	Koli/Adet Pcs/Ctn
30351606	16x6	0,75	4
30351806	18x6,5	1,0	4
30352007	20x7	1,9	2
30352408	24x8	2,5	2







» Ölçülü Mayonez Kabı

Calibrated Mixing Bowl

Kod Code	Øxh (cm) Øxh (cm)	Koli/Adet Pcs/Ctn
35050016	16x8	4
35050020	20x10	4
35050024	24x12	4
35050030	30x15	2
35050036	36x18	2



» Ölçülü Maşrapa

Calibrated Bain-Marie Pot

Kod Code	Øxh (cm) Øxh (cm)	Koli/Adet Pcs/Ctn
35701416	14x16	2
35701618	16x18	2
35701820	18x20	2
35702022	20x22	2



» Helvane Süzgeç

Colander

Kod Code	Ø (cm) Ø (cm)	Koli/Adet Pcs/Ctn
30423609	36x9	3
30423812	38x12	3
30424512	45x12	3
30425012	50x12	2
30426012	60x14	2
30427014	70x14	2
30428016	80x16	1



» Süzgeç Kaçarola

Colander for Sauce Pan

Kod Code	Ø (cm) Ø (cm)	Koli/Adet Pcs/Ctn
31380005	20x13	2
31380006	24x15	2
31380020	28x17	2



» Pasta Standı  
Cake Stand

Kod Code	Øxh (cm) Øxh (cm)	Koli/Adet Pcs/Ctn
32502005	20x5	2
32502205	22x5	2
32502405	24x5	2
32503005	30x5	2
32503605	36x5	2
32502210	22x10	2
32502410	24x10	2
32503010	30x10	2
32503610	36x10	2



» Halka Saplı Şampanya Kova  
Champagne/Wine Bucket

Kod Code	Ölçü (cm) Dim. (cm)	Koli/Adet Pcs/Ctn
36752221	Ø 21x22	6

» Şampanya Kova Standı  
Champagne Bucket Stand

Kod Code	Ölçü (cm) Dim. (cm)	Koli/Adet Pcs/Ctn
37752222	65	1







## Gastronorm Kuvvet Özellikleri

- ° Kuvvetlendirilmiş köşeler
- ° 2/1 - 1/9 aralığında geniş ölçü seçeneği
- ° 20-200 mm aralığında derinlik seçeneği
- ° Standart GN, saplı GN, ve delilikli GN çeşitleri
- ° Standart, kepçe delikli ve sızdırmaz contalı kapak çeşitleri
- ° İstiflenebilir
- ° Hazırlık, dondurma, depolama, yeniden ısıtma, ve servis için uygun

## GN Food Pan Specs

- ° Reinforced Edges
- ° Sizes from 2/1 to 1/9
- ° 20-200 mm Depth
- ° Standard, Handled and Perforated Types
- ° Standard, Notched and Sealed Lid Types
- ° Stackable
- ° Suitable for Preparing, Freezing, Storage, Reheating and Serving

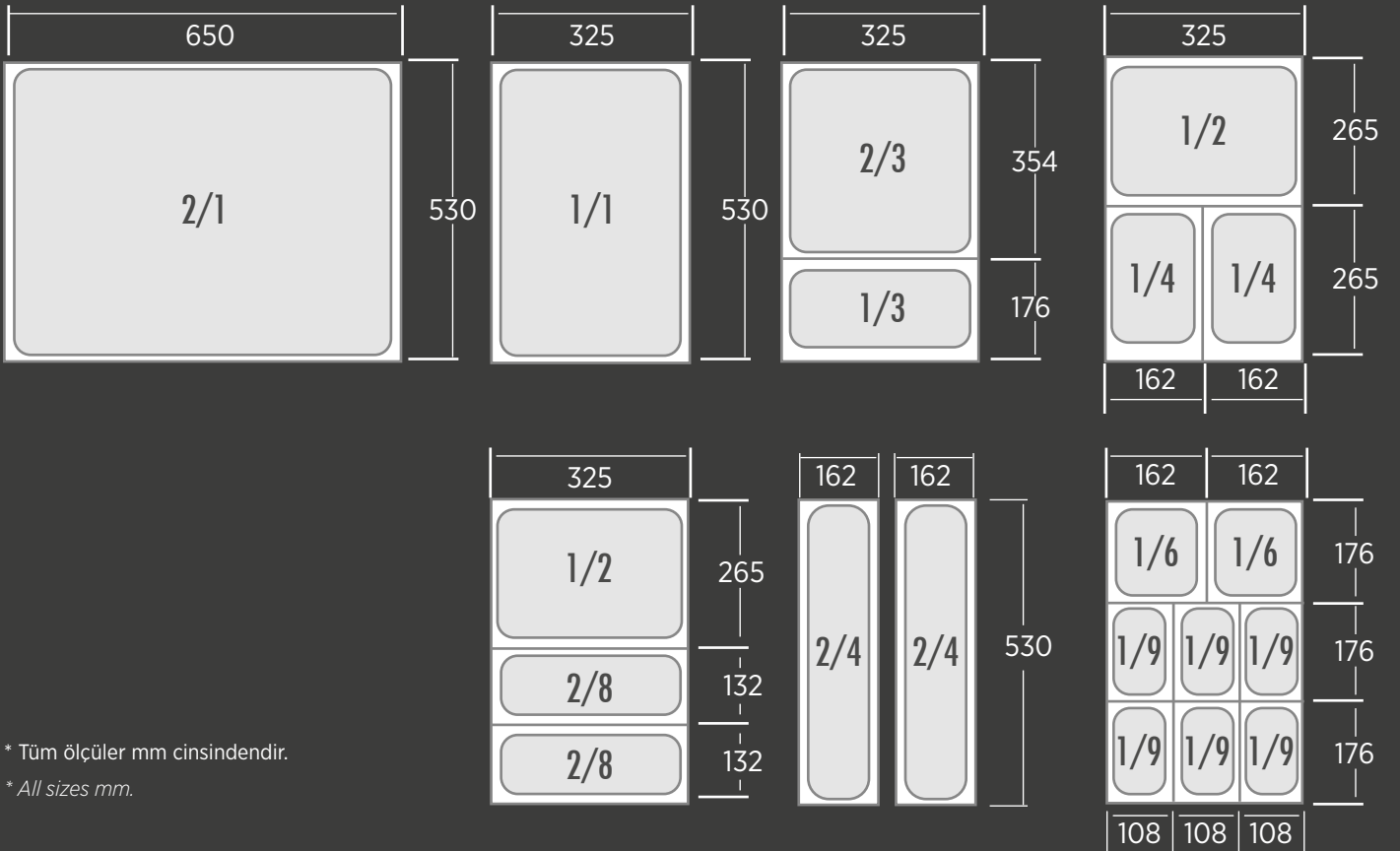



\* Tüm ölçüler mm cinsindedir.

\* All sizes mm.



Standart Gastronorm Kvetler  
GN Food Pans

		Kod Code	Derinlik (mm) Depth (mm)	Lt Lt	Koli/Adet Pcs/Ctn
	<b>2/1</b> 650x530	31021010	10	2,5	10
		31021020	20	5,0	10
		31021040	40	10,0	10
		31021065	65	18,5	10
		31021100	100	28,5	5
		31021150	150	42,5	5
		31021200	200	57,5	3
	<b>1/1</b> 530x325	31011010	10	1,25	20
		31011020	20	2,5	20
		31011040	40	5,0	20
		31011065	65	9,0	11
		31011100	100	14,0	10
		31011150	150	21,0	10
		31011200	200	28,0	8
	<b>2/3</b> 354x325	31023020	20	1,5	20
		31023040	40	3,0	20
		31023065	65	5,5	20
		31023100	100	9,0	20
		31023150	150	13,0	15
		31023200	200	18,0	10
	<b>1/2</b> 325x265	31012020	20	1,25	25
		31012040	40	2,0	30
		31012065	65	4,0	30
		31012100	100	6,5	25
		31012150	150	9,5	13
		31012200	200	12,5	10
	<b>1/3</b> 325x176	31013020	20	0,75	60
		31013040	40	1,5	40
		31013065	65	2,5	40
		31013100	100	4,0	30
		31013150	150	5,7	30
		31013200	200	7,8	20



Standart Gastronorm Kvetler GN Food Pans		Kod Code	Derinlik (mm) Depth (mm)	Lt Lt	Koli/Adet Pcs/Ctn
	<b>1/4</b> 265x162	31014020	20	0,5	30
		31014040	40	1,0	30
		31014065	65	1,8	30
		31014100	100	2,8	30
		31014150	150	4,0	30
		31014200	200	5,5	20
	<b>2/4</b> 530x162	31024020	20	0,5	20
		31024040	40	1,3	18
		31024065	65	2,3	16
		31024100	100	5,2	14
	<b>2/8</b> 325x132	31028065	65	1,0	10
		31028100	100	2,0	10
	<b>1/6</b> 176x162	31016065	65	1,0	40
		31016100	100	1,6	40
		31016150	150	2,4	30
		31016200	200	3,4	20
	<b>1/9</b> 176x108	31019065	65	0,6	80
		31019100	100	1,0	70

## Süzgeçli Gastronorm Küvetler / Perforated GN Food Pans

Süzgeçli Gastronorm Küvetler  
Perforated GN Food Pans





30

		Kod Code	Derinlik (mm) Depth (mm)	Koli/Adet Pcs/Ctn
	<b>2/1</b> 650x530	30921020	20	10
		30921040	40	10
		30921065	65	10
		30921100	100	5
		30921150	150	5
		30921200	200	3
	<b>1/1</b> 530x325	30911020	20	20
		30911040	40	20
		30911065	65	11
		30911100	100	10
		30911150	150	10
		30911200	200	8
	<b>2/3</b> 354x325	30923020	20	20
		30923040	40	20
		30923065	65	20
		30923100	100	20
		30923150	150	15
		30923200	200	10
	<b>1/2</b> 325x265	30912020	20	25
		30912040	40	30
		30912065	65	30
		30912100	100	25
		30912150	150	13
		30912200	200	10

## Süzgeçli Gastronorm Küvetler / Perforated GN Food Pans

Süzgeçli Gastronorm Küvetler  
Perforated GN Food Pans

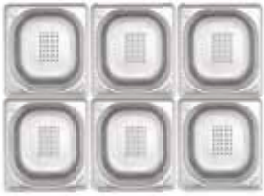

		Kod Code	Derinlik (mm) Depth (mm)	Koli/Adet Pcs/Ctn
	<b>1/3</b> 325x176	30913020	20	60
		30913040	40	40
		30913065	65	40
		30913100	100	30
		30913150	150	30
		30913200	200	20
	<b>1/4</b> 265x162	30914020	20	30
		30914040	40	30
		30914065	65	30
		30914100	100	30
		30914150	150	30
		30914200	200	20
	<b>1/6</b> 176x132	30916065	65	40
		30916100	100	40
		30916150	150	30
		30916200	200	20

31





## Saplı Gastronorm Kvetler / GN Food Pans w/Handle







Saplı Gastronorm Kvetler  
GN Food Pans w/Handle

32

		Kod Code	Derinlik (mm) Depth (mm)	Lt Lt	Koli/Adet Pcs/Ctn
	<b>2/1</b> 650x530	31121065	65	18,5	10
		31121100	100	28,5	5
		31121150	150	42,5	5
		31121200	200	57,5	3
	<b>1/1</b> 530x325	31111065	65	9,0	11
		31111100	100	14,0	10
		31111150	150	21,0	10
		31111200	200	28,0	8
	<b>2/3</b> 354x325	31123065	65	5,5	20
		31123100	100	9,0	20
		31123150	150	13,0	15
		31123200	200	18,0	10
	<b>1/2</b> 325x265	31112065	65	4,0	30
		31112100	100	6,5	25
		31112150	150	9,5	13
		31112200	200	12,5	10

## Saplı Gastronorm Küvetler / GN Food Pans w/Handle

Saplı Gastronorm Küvetler GN Food Pans w/Handle					
		Kod Code	Derinlik (mm) Depth (mm)	Lt Lt	Koli/Adet Pcs/Ctn
	<b>1/3</b> 325x176	31113065	65	2,5	40
		31113100	100	4,0	30
		31113150	150	5,7	30
		31113200	200	7,8	20
	<b>1/4</b> 265x162	31114065	65	1,8	30
		31114100	100	2,8	30
		31114150	150	4,0	30
		31114200	200	5,5	20
	<b>1/6</b> 176x162	31116065	65	1,0	40
		31116100	100	1,6	40
		31116150	150	2,4	30
		31116200	200	3,4	20



**NEW**



» Sızdırmaz Contalı 1/1

Lid w/Hermetic Seal 1/1

Kod Code	Model Model	Ölçü (mm) Dim (mm)	Koli/Adet Pcs/Ctn
32023311	1/1	530x325	15



» Sızdırmaz Contalı

Lid w/Hermetic Seal

Kod Code	Model Model	Ölçü (mm) Dim (mm)	Koli/Adet Pcs/Ctn
31923312	1/2	325x265	15
31923313	1/3	325x176	15
31923314	1/4	265x162	20



» Standart

Standart

Kod Code	Model Model	Ölçü (mm) Dim (mm)	Koli/Adet Pcs/Ctn
31921530	2/1	650x530	15
31911325	1/1	530x325	15
31923325	2/3	354x325	20
31924300	2/4	530x162	12
31928300	2/8	325x132	12
31912265	1/2	325x265	30
31913176	1/3	325x176	30
31914162	1/4	265x162	30
31916162	1/6	176x162	30
31919108	1/9	176x108	30



» Sap Delikli

Lid w/Handle Hole

Kod Code	Model Model	Ölçü (mm) Dim (mm)	Koli/Adet Pcs/Ctn
32100021	2/1	650x530	6
32100011	1/1	530x325	6
32100023	2/3	354x325	6
32100012	1/2	325x265	6
32100013	1/3	325x176	6
32100014	1/4	265x162	6
32100016	1/6	176x162	12



» Keççe Delikli

Lid w/Ladle Hole

Kod Code	Model Model	Ölçü (mm) Dim (mm)	Koli/Adet Pcs/Ctn
32100121	2/1	650x530	6
32100111	1/1	530x325	6
32100123	2/3	354x325	6
32100112	1/2	325x265	6
32100113	1/3	325x176	6
32100114	1/4	265x162	6
32100116	1/6	176x162	12



» Yapışmaz Kaplı GN (Paslanmaz)

Nonstick GN Pan

Kod Code	Ölçü (mm) Dim (mm)	Model Model	Lt Lt	Koli/Adet Pcs/Ctn
31311020	530x325	1/1-20	2,5	5
31321020	650x530	2/1-20	5	5



» Yapışmaz Kaplı GN (Alüminyum)

Nonstick GN Pan Aliminum

Kod Code	Ölçü (mm) Dim (mm)	Model Model	Lt Lt
31311030	530x325	1/1-20	5
33121030	650x530	2/1-20	5



» Süzgeç Taban

Drainer Plate

Kod Code	Ölçü (mm) Dim (mm)	Model Model	Koli/Adet Pcs/Ctn
80026565	465x265	1/1	4
80026523	285x265	2/3	4
80026520	265x220	1/2	4
80026515	265x115	1/3	4



» Dondurma Küveti

GN Ice Cream Pan

Kod Code	Lt Lt	Ölçü (mm) Dim (mm)	Koli/Adet Pcs/Ctn
31236065	4	360x170x65	15
31236100	6,1	360x170x100	15
31236120	7,3	360x170x120	15
31236150	9,2	360x170x150	15



» Gastronom Süzgeç

Colander for GN Pan

Kod Code	Koli/Adet Pcs/Ctn
70021100	1



\* GN Küvet fiyata dahil değildir.

\* GN Pan not included in price.

## Bain Marie Küvetler / Bain Marie Containers



» A

A

Kod Code	Model Model	Ölçü (mm) Dim (mm)	h (mm) h (mm)	Lt Lt	Koli/Adet Pcs/Ctn
31622235	A1	240x240	235	13	4
31622160	A2	240x240	160	9	4
31622075	A3	240x240	75	4	4
31622300	A (Kapak / Lid)	240x240			4



» B

B

Kod Code	Model Model	Ölçü (mm) Dim (mm)	h (mm) h (mm)	Lt Lt	Koli/Adet Pcs/Ctn
31611235	B1	155x155	235	5	4
31611160	B2	155x155	160	3,5	4
31611075	B3	155x155	75	1,5	4
31611300	B (Kapak / Lid)	155x155			4



» C

C

Kod Code	Model Model	Ölçü (mm) Dim (mm)	h (mm) h (mm)	Lt Lt	Koli/Adet Pcs/Ctn
31610160	C2	155x105	160	2,5	4
31610075	C3	155x105	75	1	4
31610055	C4	155x105	55	0,5	4
31610300	C (Kapak / Lid)	155x105			4



» Banket Tepsi Kenar Desenli  
Figured Tray for Open Buffet

Kod Code	Ölçü (mm) Dim. (mm)	lt	Koli/Adet Pcs/Ctn
31611005	530x325		6



» 1/1 GN Tepsi  
1/1 GN Tray

Kod Code	Ölçü (mm) Dim. (mm)	lt	Koli/Adet Pcs/Ctn
31611010	530x325x10	1,25	6
31611020	530x325x20	2,5	6
31611040	530x326x40	5	6

37



» 2/3 GN Tepsi  
2/3 GN Tray

Kod Code	Ölçü (mm) Dim. (mm)	lt	Koli/Adet Pcs/Ctn
31623010	354x325x10	0,75	6
31623020	354x325x20	1,5	6
31623040	354x325x40	3	6



» 1/2 GN Tepsi  
1/2 GN Tray

Kod Code	Ölçü (mm) Dim. (mm)	lt	Koli/Adet Pcs/Ctn
31612010	325x265x10	0,5	6
31612020	325x265x20	1,25	6
31612040	325x265x40	2,5	6

# TITAN CHAFING DISH

NEW



## Patentli Rezistanslı Camlar / Patented Heated Glasses



- Dünyada bir ilk! Buğu yapmayan rezistanslı camlar sayesinde artık yemekler kapaklar açılmadan da görülebilir. Gıdaların ısısını ve hijyenini bu sayede daha uzun süre muhafaza eder.
- Rezistanslı camlar aynı zamanda su damlalarının toplanıp yemeklere damlamasını önler.
- Ortadan ısınmaya başlayan rezistanslı camlar enerji tasarrufu sağlar.
- Farklı renk ve görünümde paslanmaz çelik aksamlar açık büfelere yepyeni bir tarz katar.
- Temperli cam üzerindeki özel izolasyon sayesinde elektrik ve su buharı arasında kısa devre oluşmasını engeller.
- Özel tasarım hidrolik menteşeler kapağın yavaşça kapanmasına yardımcı olur.
- Farklı renk alternatifleri ile otelinizin tasarımına uyum sağlar.
- Tüm parçalar çıkarılabilir ve makinada yıkanabilir.

- A first in the world! Thanks to the anti-fog resistant glasses, the dishes can now be seen without opening the lids. In this way, the temperature and hygiene of the food can be preserved for a longer period of time.
- Resistance glasses also prevent water droplets from collecting and dripping onto the food.
- Resistive glasses that start to heat from the middle save energy.
- Stainless steel components in different colors and appearances add a brand new style to open buffets.
- Thanks to the special insulation on the tempered glass, short circuit between electricity and water vapor is prevented.
- Specially designed hydraulic hinges help the lid to close slowly.
- It adapts to the design of your hotel with different color alternatives.
- All parts are removable and machine washable

39

Titan Chafing Dish

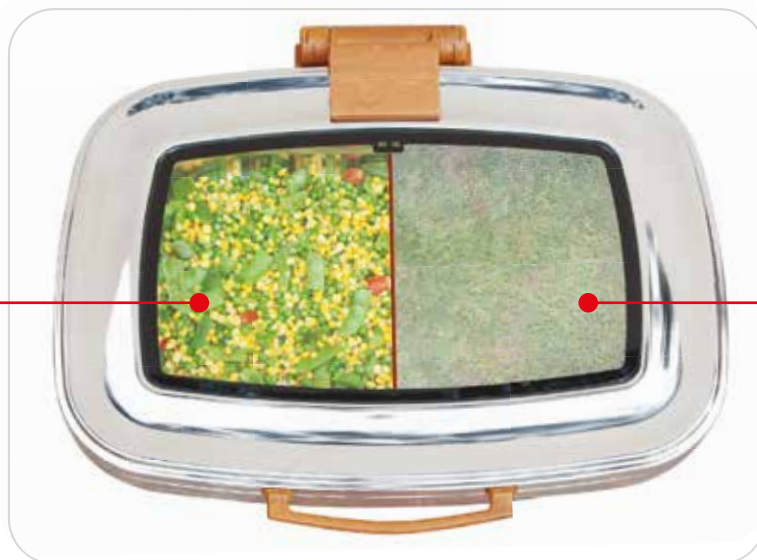
Diğer Chafing Dishler  
Other Chafing Dishes



Çıkarılabilir Kapak  
Removable Cover

Rezistanslı Cam Kapak  
Resistance Glass Window

Hidrolik Kapak  
Hydraulic Lid



- 1 Patentli rezistanslı camlar  
Patented resistance glasses
- 2 Ahşap görünümlü paslanmaz çelik aksamlar  
Wood-look stainless steel components
- 3 90° de sabitlenebilir kapak  
Stable at 90°
- 4 100 W rezistans gücü  
100 W resistance power
- 5 Çıkarılabilir Elektrik Kablosu  
Removable power cord



# TITAN CHAFING DISH



**NEW**

54010101

İndüksiyon ocaklara uygundur  
Suitable for Induction Plates



57012011

42

Kod Code	Model Model	Renk Color	Ölçü (cm) Dim. (cm)
57012211	GN 1/1 - 9 lt. Rezistanslı Kapak/ w/ Heated Lid	Krom / Chrome	64x55,5x16,5
57012011	GN 1/1 - 9 lt.	Krom / Chrome	64x55,5x16,5
57013012	GN 1/1 Ayaklı Stand / Stand	Ahşap / Wood	63x44,5x11,5
57014012	GN 1/1 Ayaklı Stand / Stand	Kırmızı / Red	63x44,5x11,5
57015012	GN 1/1 Ayaklı Stand / Stand	Siyah / Black	63x44,5x11,5
54010101	İndüksiyon Isıtıcı 1000W/220V Induction Heating 1000W/220V		

57013012



57014012



57015012



Patentli rezistanslı camlar  
Patented resistance glasses



Hidrolik Kapak  
Hydraulic Lid



Çıkarılabilir Elektrik Kablosu  
Removable power cord



NEW



54010101

İndüksiyon ocaklara uygundur  
Suitable for Induction Plates



57013011

57013012

» Kod Code	Model Model	Ölçü (cm) Dim. (cm)
57013211	GN 1/1 - 9 lt. Ahşap Rezistanslı Kapak/ w/ Heated Lid Wood	64x55,5x16,5
57013011	GN 1/1 - 9 lt. Ahşap / Wood	64x55,5x16,5
57013012	GN 1/1 Ayaklı Stand Ahşap / Stand Wood	63x44,5x11,5
54010101	İndüksiyon Isıtıcı 1000W/220V Induction Heating 1000W/220V	

43

» Kod Code	Model Model	Ölçü (cm) Dim. (cm)
57014211	GN 1/1 - 9 lt. Kırmızı Rezistanslı Kapak/ w/ Heat Resistant Lid Red	64x55,5x16,5
57014011	GN 1/1 - 9 lt. Kırmızı / Red	64x55,5x16,5
57014012	GN 1/1 Ayaklı Stand Kırmızı / Stand Red	63x44,5x11,5
54010101	İndüksiyon Isıtıcı 1000W/220V Induction Heating 1000W/220V	

» Kod Code	Model Model	Ölçü (cm) Dim. (cm)
57015211	GN 1/1 - 9 lt. Siyah Rezistanslı Kapak/ w/ Heat Resistant Lid Black	64x55,5x16,5
57015011	GN 1/1 - 9 lt. Siyah / Black	64x55,5x16,5
57015012	GN 1/1 Ayaklı Stand Siyah / Stand Black	63x44,5x11,5
54010101	İndüksiyon Isıtıcı 1000W/220V Induction Heating 1000W/220V	

57014011



57014012

57015011



57015012

**NEW**

57011032



54010101

İndüksiyon ocaklara uygundur  
Suitable for Induction Plates



Kod Code	Model Model	Renk Color	Ölçü (cm) Dim. (cm)
57011232	GN 2/3 - 5,5 lt. Rezistanslı Kapak/ w/ Heated Lid	Krom / Chrome	48,5x54x16,5
57011032	GN 2/3 - 5,5 lt.	Krom / Chrome	48,5x54x16,5
57013035	GN 2/3 Ayaklı Stand/ Stand	Ahşap / Wood	47x43x11,5
57014035	GN 2/3 Ayaklı Stand/ Stand	Kırmızı / Red	47x43x11,5
57015035	GN 2/3 Ayaklı Stand/ Stand	Siyah / Black	47x43x11,5
54010101	İndüksiyon Isıtıcı 1000W/220V Induction Heating 1000W/220V		

44

57013035



Patentli rezistanslı camlar  
Patented resistance glasses



57014035



Hidrolik Kapak  
Hydraulic Lid



57015035



Çıkarılabilir Elektrik Kablosu  
Removable power cord



NEW



54010101

İndüksiyon ocaklara uygundur  
Suitable for Induction Plates



57013032

57013035

» Kod Code	Model Model	Ölçü (cm) Dim. (cm)
57013232	GN 2/3 - 5,5 lt. Rezistanslı Kapak Ahşap / w/ Heated Lid Wood	48,5x54x16,5
57013032	GN 2/3 - 5,5 lt. Ahşap / Wood	48,5x54x16,5
57013035	GN 2/3 Ayaklı Stand Ahşap / Stand Wood	47x43x11,5
54010101	İndüksiyon Isıtıcı 1000W/220V Induction Heating 1000W/220V	

45

» Kod Code	Model Model	Ölçü (cm) Dim. (cm)
57014232	GN 2/3 - 5,5 lt. Rezistanslı Kapak Kırmızı / w/ Heated Lid Red	48,5x54x16,5
57014032	GN 2/3 - 5,5 lt. Kırmızı / Red	48,5x54x16,5
57014035	GN 2/3 Ayaklı Stand Kırmızı / Stand Red	47x43x11,5
54010101	İndüksiyon Isıtıcı 1000W/220V Induction Heating 1000W/220V	

» Kod Code	Model Model	Ölçü (cm) Dim. (cm)
57015232	GN 2/3 - 5,5 lt. Rezistanslı Kapak Siyah / w/ Heated Lid Black	48,5x54x16,5
57015032	GN 2/3 - 5,5 lt. Siyah / Black	48,5x54x16,5
57015035	GN 2/3 Ayaklı Stand Siyah / Stand Black	47x43x11,5
54010101	İndüksiyon Isıtıcı 1000W/220V Induction Heating 1000W/220V	

57014032



57014035

57015032



57015035

NEW



54010101

İndüksiyon ocaklara uygundur  
Suitable for Induction Plates



57012150

46

Kod Code	Model Model	Renk Color	Ölçü (cm) Dim. (cm)
57012151	1/2 - 4 lt. Rezistanslı Kapak/ w/ Heated Lid	Krom / Chrome	45x40x14
57012150	GN 1/2 - 4 lt.	Krom / Chrome	45x40x14
57012260	GN 2/3 Ayaklı Stand/ Stand	Ahşap / Wood	43x37x11,5
57012270	GN 2/3 Ayaklı Stand/ Stand	Kırmızı / Red	43x37x11,5
57012280	GN 2/3 Ayaklı Stand/ Stand	Siyah / Black	43x37x11,5
54010101	İndüksiyon Isıtıcı 1000W/220V Induction Heating 1000W/220V		

57012260



Patentli rezistanslı camlar  
Patented resistance glasses



57012270



Hidrolik Kapak  
Hydraulic Lid



57012280



Çıkarılabilir Elektrik Kablosu  
Removable power cord



NEW



54010101

İndüksiyon ocaklara uygundur  
Suitable for Induction Plates



57012160

57012260

» Kod Code	Model Model	Ölçü (cm) Dim. (cm)
57012161	GN 1/2 - 4 lt. Rezistanslı Kapak Ahşap/ w/ Heated Lid Wood	45x40x14
57012160	GN 1/2 - 4 lt. Ahşap / Wood	45x40x14
57012260	GN 1/2 Ayaklı Stand Ahşap/ Stand Wood	43x37x11,5
54010101	İndüksiyon Isıtıcı 1000W/220V Induction Heating 1000W/220V	

47

» Kod Code	Model Model	Ölçü (cm) Dim. (cm)
57012171	GN 1/2 - 4 lt. Rezistanslı Kapak Kırmızı/ w/ Heated Lid Red	45x40x14
57012170	GN 1/2 - 4 lt. Kırmızı / Red	45x40x14
57012270	GN 1/2 Ayaklı Stand Kırmızı / Stand Red	43x37x11,5
54010101	İndüksiyon Isıtıcı 1000W/220V Induction Heating 1000W/220V	

» Kod Code	Model Model	Ölçü (cm) Dim. (cm)
57012181	GN 1/2 - 4 lt. Rezistanslı Kapak Siyah/ w/ Heated Lid Black	45x40x14
57012180	GN 1/2 - 4 lt. Siyah / Black	45x40x14
57012280	GN 1/2 Ayaklı Stand Siyah / Stand Black	43x37x11,5
54010101	İndüksiyon Isıtıcı 1000W/220V Induction Heating 1000W/220V	

57012170



57012270

57012180



57012280



NEW

57011060



54010101

İndüksiyon ocaklara uygundur  
Suitable for Induction Plates



48

Kod Code	Model Model	Renk Color	Ölçü (cm) Dim. (cm)
5701126	Yuvarlak 5,7 Lt. Rezistanslı Kapak/ Round w/ Heated Lid	Krom / Chrome	46x40x19
57011060	Yuvarlak 5,7 Lt. / Round 5,7 Lt	Krom / Chrome	46x40x19
57013160	Yuvarlak Ayaklı Stand / Round Stand	Ahşap / Wood	42x42x11,5
57014160	Yuvarlak Ayaklı Stand / Round Stand	Kırmızı / Red	42x42x11,5
57015160	Yuvarlak Ayaklı Stand / Round Stand	Siyah / Black	42x42x11,5
54010101	İndüksiyon Isıtıcı 1000W/220V Induction Heating 1000W/220V		

57013160



57014160



57015160



Patentli rezistanslı camlar  
Patented resistance glasses



Hidrolik Kapak  
Hydraulic Lid



Çıkarılabilir Elektrik Kablosu  
Removable power cord



NEW

57013060



57013160



54010101

İndüksiyon ocaklara uygundur  
Suitable for Induction Plates

» Kod Code	Model Model	Ölçü (cm) Dim. (cm)
57013260	Yuvarlak 5,7 Lt. Rezistanslı Kapak Ahşap/ Round w/ Heated Lid Wood	46x40x19
57013060	Yuvarlak 5,7 Lt. Ahşap / Round 5,7 Lt. Wood	46x40x19
57013160	Yuvarlak Ayaklı Stand Ahşap/ Round Stand Wood	42x42x11,5
54010101	İndüksiyon Isıtıcı 1000W/220V Induction Heating 1000W/220V	

49

» Kod Code	Model Model	Ölçü (cm) Dim. (cm)
57014260	Yuvarlak 5,7 Lt. Rezistanslı Kapak Kırmızı/ Round w/ Heated Lid Red	46x40x19
57014060	Yuvarlak 5,7 Lt. Kırmızı / Round 5,7 Lt. Red	46x40x19
57014160	Yuvarlak Ayaklı Stand Kırmızı / Round Stand Red	42x42x11,5
54010101	İndüksiyon Isıtıcı 1000W/220V Induction Heating 1000W/220V	

» Kod Code	Model Model	Ölçü (cm) Dim. (cm)
57015260	Yuvarlak 5,7 Lt. Rezistanslı Kapak Siyah/ Round w/ Heated Lid Black	46x40x19
57015060	Yuvarlak 5,7 Lt. Siyah / Round 5,7 Lt. Black	46x40x19
57015160	Yuvarlak Ayaklı Stand Siyah / Round Stand Black	42x42x11,5
54010101	İndüksiyon Isıtıcı 1000W/220V Induction Heating 1000W/220V	

57014060



57014160

57015060



57015160

NEW



54010101

İndüksiyon ocaklara uygundur  
Suitable for Induction Plates



57011015

Kod Code	Model Model	Renk Color	Ölçü (cm) Dim. (cm)
57011215	Çorbalık 14,3 Lt. Rezistanslı Kapak/ Soup Station w/ Heated Lid	Krom / Chrome	46x40x25
57011015	Çorbalık 14,3 Lt. / Soup Station 14,3 Lt.	Krom / Chrome	46x40x25
57013160	Çorbalık Ayaklı Stand / Soup Station Stand	Ahşap / Wood	42x42x11,5
57014160	Çorbalık Ayaklı Stand / Soup Station Stand	Kırmızı / Red	42x42x11,5
57015160	Çorbalık Ayaklı Stand / Soup Station Stand	Siyah / Black	42x42x11,5
54010101	İndüksiyon Isıtıcı 1000W/220V Induction Heating 1000W/220V		

50

57013160



Patentli rezistanslı camlar  
Patented resistance glasses



57014160



Hidrolik Kapak  
Hydraulic Lid



57015160



Çıkarılabilir Elektrik Kablosu  
Removable power cord



NEW



54010101

İndüksiyon ocaklara uygundur  
Suitable for Induction Plates



57013015

57013160

» Kod Code	Model Model	Ölçü (cm) Dim. (cm)
57013215	Çorbalık 14,3 Lt. Rezistanslı Kapak Ahşap/ w/ Heated Lid Wood Soup Station	46x40x25
57013015	Çorbalık 14,3 Lt. Ahşap / Soup Station 14,3 Lt. Wood	46x40x25
57013160	Çorbalık Ayaklı Stand Ahşap/ Soup Station Stand Wood	42x42x11,5
54010101	İndüksiyon Isıtıcı 1000W/220V Induction Heating 1000W/220V	

51

» Kod Code	Model Model	Ölçü (cm) Dim. (cm)
57014215	Çorbalık 14,3 Lt. Rezistanslı Kapak Kırmızı/ w/ Heated Lid Red Soup Station	46x40x25
57014015	Çorbalık 14,3 Lt. Kırmızı/ Soup Station 14,3 Lt. Red	46x40x25
57014160	Çorbalık Ayaklı Stand Kırmızı / Soup Station Stand Red	42x42x11,5
54010101	İndüksiyon Isıtıcı 1000W/220V Induction Heating 1000W/220V	

» Kod Code	Model Model	Ölçü (cm) Dim. (cm)
57015215	Çorbalık 14,3 Lt. Rezistanslı Kapak Siyah/ w/ Heated Lid Black Soup Station	46x40x25
57015015	Çorbalık 14,3 Lt. Siyah/Soup Station 14,3 Lt. Black	46x40x25
57015160	Çorbalık Ayaklı Stand Siyah/Soup Station Stand Black	42x42x11,5
54010101	İndüksiyon Isıtıcı 1000W/220V Induction Heating 1000W/220V	

57014015



57014160

57015015



57015160



» Tabansız Taşıma Kovası (Kapaklı)  
Carrying Container w/o Sandwich Bottom

Kod Code	Øxh (cm) Øxh (cm)	Lt Lt	Koli/Adet Pcs/Ctn
35512428	24x28	12,5	4
35513028	30x28	20	2
35513032	30x32	21	2
35513636	36x36	36,6	1
35514040	40x40	50	1
35514545	45x45	70	1
35515050	50x50	100	1



» Tabansız Taşıma Kovası (Silikon Conta Kapaklı)  
Carrying Container w/o Sandwich Bottom-Lid w/Silicone Seal

Kod Code	Øxh (cm) Øxh (cm)	Lt Lt	Koli/Adet Pcs/Ctn
35532428	24x28	12,5	4
35533028	30x28	20	2
35533032	30x32	21	2
35533636	36x36	36,6	1
35534040	40x40	50	1
35534545	45x45	70	1

\* Ø36, Ø40, Ø45, Ø50 ölçüleri sabit saplıdır  
\* Ø36, Ø40, Ø45, Ø50 has fixed handles



» Tabanlı Taşıma Kovası (Kapaklı)  
Carrying Container w/Sandwich Bottom

Kod Code	Øxh (cm) Øxh (cm)	Lt Lt	Koli/Adet Pcs/Ctn
35502428	24x28	12,5	4
35503028	30x28	20	2
35503032	30x32	21	2
35503636	36x36	36,6	1
35504040	40x40	50	1
35504545	45x45	70	1
35505050	50x50	100	1

\* Ø36, Ø40, Ø45, Ø50 ölçüleri sabit saplıdır

\* Ø36, Ø40, Ø45, Ø50 has fixed handles



» Tabanlı Taşıma Kovası (Silikon Conta Kapaklı)  
Carrying Container w/Sandwich Bottom-Lid w/Silicone Seal

Kod Code	Øxh (cm) Øxh (cm)	Lt Lt	Koli/Adet Pcs/Ctn
35542428	24x28	12,5	4
35543028	30x28	20	2
35543032	30x32	21	2
35543636	36x36	36,6	1
35544040	40x40	50	1
35544545	45x45	70	1

» Silikon Conta  
Silicone Seals

Kod Code	Ø (cm) Ø (cm)	Koli/Adet Pcs/Ctn
35510024	24	2
35510030	30	2
35510036	36	2
35510040	40	2
35510045	45	2

\* Gıda tüzüğüne uygundur.

\* Food safe compliances.





» İzoleli Taşıma Kovası  
Double Wall Carrying Container

Kod Code	Øxh (cm) Øxh (cm)	Lt Lt	Koli/Adet Pcs/Ctn
35503217	32x17	10	1
35503222	32x22	14	1
35503230	32x30	20	1
35503236	32x36	24	1
35503248	32x48	32	1
35505030	50x30	43	1



» Musluklu Taşıma Kovası  
Carrying Container w/Faucet

Kod Code	Øxh (cm) Øxh (cm)	Lt Lt	Koli/Adet Pcs/Ctn
35412428	24x28	12,5	4
35413028	30x28	20	2
35413032	30x32	21	2
35413636	36x36	36,6	1
35414040	40x40	50	1
35414545	45x45	70	1
35415050	50x50	100	1



» Sefer Tası Standart  
Standard Portable Food Containers

Kod Code	Øxh (cm) Øxh (cm)	AdxLt PcsxLt	Koli/Adet Pcs/Ctn
30631808	18x8x3	3x2	4
30641808	18x8x4	4x2	4
30632010	20x9x3	3x3	4
30642010	20x9x4	4x3	4
30632414	24x14x3	3x6	2
30642414	24x14x4	4x6	2
30633014	30x14x3	3x10	1
30643014	30x14x4	4x10	2



» Sefer Tası İzoleli  
Double Wall Portable Food Containers

Kod Code	Øxh (cm) Øxh (cm)	AdxLt PcsxLt	Koli/Adet Pcs/Ctn
35502092	20x11x2	2x3	4
35502093	20x11x3	3x3	4
35502094	20x11x4	3x4	4





» Taşıma Tepsisi Kapaklı  
Carrying Tray w/Clip-on Cover

Kod Code	Ölçü Dims. (cm)	Koli/Adet Pcs/Ctn
30714565	40x60x5	2
30714568	40x60x8	2
30714561	40x60x10	2
30715355	50x35x5	2
30715358	50x35x8	2
30715310	50x35x10	2
30715705	50x70x5	3
30715708	50x70x8	3
30715710	50x70x10	3



» Taşıma Tepsisi Kapaksız  
Carrying Tray

Kod Code	Ölçü Dims. (cm)	Koli/Adet Pcs/Ctn
30704565	40x60x5	2
30704568	40x60x8	2
30704561	40x60x10	2
30705355	50x35x5	2
30705358	50x35x8	2
30705310	50x35x10	2
30705705	50x70x5	3
30705708	50x70x8	3
30705710	50x70x10	3



» Kapak  
Cover

Kod Code	Ölçü Dims. (cm)	Koli/Adet Pcs/Ctn
30705711	40x60	2
30705713	50x35	2
30705712	50x70	2



» 2 Katlı Servis Arabası (Demonte)  
Demontable Service Trolley

Kod Code	Ölçü (cm) Dim. (cm)	Koli/Adet Pcs/Ctn
34266018	90x60x18	1



» 3 Katlı Servis Arabası (Demonte)  
Demontable Service Trolley

Kod Code	Ölçü (cm) Dim. (cm)	Koli/Adet Pcs/Ctn
34266022	90x60x22	1





» Bulaşık Toplama Arabası  
Utility Rack

Kod Code	Model Model	Kapasite Capacity	Ölçü (cm) Dim. (cm)	Koli/Adet Pcs/Ctn
48013753	Tekli Single	13 Ad. 37x53 Tepsi 13 Pcs. 37x53 Tray	43x56x171	1
48023753	İkili Double	26 Ad. 37x53 Tepsi 26 Pcs. 37x53 Tray	83x56x171	1
48033753	Üçlü Triple	39 Ad. 37x53 Tepsi 39 Pcs. 37x53 Tray	123x56x171	1
48043753	Dörtlü Quadruple	52 Ad. 37x53 Tepsi 52 Pcs. 37x53 Tray	175x77x171	1



» Tepsi Taşıma Arabası  
Tray Cart

Kod Code	Model Model	Kapasite Capacity	Ölçü (cm) Dim. (cm)	Koli/Adet Pcs/Ctn
48014060	Tekli Single	15 Ad. 40x60 Tepsi 15 Pcs. 40x60 Tray	40x63x165	1
48024060	İkili Double	30 Ad. 40x60 Tepsi 30 Pcs. 40x60 Tray	90x63x165	1
48015070	Tekli Single	15 Ad. 50x70 Tepsi 15 Pcs. 50x70 Tray	56x73x170	1

56



» Tepsi Tasıma Arabası GN 1/1  
Tray Cart GN 1/1

Kod Code	Model Model	Kapasite Capacity	Ölçü (cm) Dim. (cm)	Koli/Adet Pcs/Ctn
48011009	Tekli Single	9 Ad. GN 1/1 Tepsi 9 Pcs. GN 1/1 Tray	38x56x105	1
48011017	Tekli Single	17 Ad. GN 1/1 Tepsi 17 Pcs. GN 1/1 Tray	38x56x172	1
48011034	İkili Double	34 Ad. GN 1/1 Tepsi 34 Pcs. GN 1/1 Tray	74x56x172	1



» Tepsi Tasıma Arabası GN 2/1  
Tray Cart GN 2/1

Kod Code	Model Model	Kapasite Capacity	Ölçü (cm) Dim. (cm)	Koli/Adet Pcs/Ctn
48012109	Tekli Single	9 Ad. GN 2/1 Tepsi 9 Pcs. GN 2/1 Tray	59x68x105	1
48012117	Tekli Single	17 Ad. GN 2/1 Tepsi 17 Pcs. GN 2/1 Tray	59x68x172	1
48012134	İkili Double	34 Ad. GN 2/1 Tepsi 34 Pcs. GN 2/1 Tray	115x68x172	1



» Saksılık

Pot w/o Bottom and w/o Handles

Kod Code	Øxh(cm) Øxh(cm)	Lt Lt	Koli/Adet Pcs/Ctn
35522400	24x28	12,5	2
35522800	28x28	17,2	2
35523200	32x32	26	1
35503600	36x36	36,6	1
35504000	40x40	50	1
35505000	50x50	100	1
35506000	60x55	155,4	1



» Tekerlekli Çöp Kovası

Rubbish Bin w/Wheels

Kod Code	Model Model	Øxh(cm) Øxh(cm)	Koli/Adet Pcs/Ctn
35524040	Kapaklı w/Wheel-w/o Lid	40x40	1
35524041	Kapaklı w/Wheel-w/Lid	40x40	1

57



» Eyme

Sink

Kod Code	Ölçü (cm) Dim. (cm)	Koli/Adet Pcs/Ctn
30804425	40x40x25	5
30804525	40x50x25	5
30805525	50x50x25	5







plast | port<sup>®</sup>  
by **KAPP**

# ELEKTRIKLİ/ELECTRICAL THERMOCASE

NEW

plast | port<sup>®</sup>  
by **KAPP**

60 Thermocase<sup>®</sup> P600ME **CE**



» Thermobox Mentşeli Elektrikli P600ME  
Termobox Electrical 600ME (Side-Hinged)

Kod Code	Koli/Adet Pcs/Ctn
46012600	1



GN 1/1 YÜKLEME SEÇENEKLERİ / GN 1/1 TRAY LOADING OPTIONS

NEW

<p><b>54 lt</b></p>  <p>GN 1/1 *65 GN 1/1 *65 GN 1/1 *65 GN 1/1 *65 GN 1/1 *65 GN 1/1 *65</p> <p>245 Porsiyon 245 Portions</p>	<p><b>57 lt</b></p>  <p>GN 1/1 *65 GN 1/1 *65 GN 1/1 *65 GN 1/1 *65 GN 1/1 *150</p> <p>260 Porsiyon 260 Portions</p>	<p><b>53 lt</b></p>  <p>GN 1/1 *65 GN 1/1 *65 GN 1/1 *100 GN 1/1 *150</p> <p>240 Porsiyon 240 Portions</p>	<p><b>58 lt</b></p>  <p>GN 1/1 *65 GN 1/1 *100 GN 1/1 *100 GN 1/1 *150</p> <p>265 Porsiyon 265 Portions</p>
<p><b>56 lt</b></p>  <p>GN 1/1 *100 GN 1/1 *100 GN 1/1 *100 GN 1/1 *100</p> <p>255 Porsiyon 255 Portions</p>	<p><b>53 lt</b></p>  <p>GN 1/1 *100 GN 1/1 *100 GN 1/1 *200</p> <p>240 Porsiyon 240 Portions</p>	<p><b>63 lt</b></p>  <p>GN 1/1 *100 GN 1/1 *150 GN 1/1 *200</p> <p>290 Porsiyon 290 Portions</p>	<p><b>56 lt</b></p>  <p>GN 1/1 *200</p> <p>255 Porsiyon 255 Portions</p>

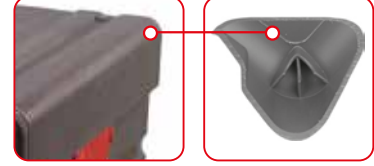

Ekstra güçlendirilmiş köşe yapısı  
Extra Reinforced Edges



ÜRÜN ÖZELLİKLERİ

- 1 Yalnızca gövde bulaşık makinasında yıkanabilir.
- 2 +100°C sığağa, -40°C soğuga dayanıklıdır.
- 3 Ürün iç yüzeyinin kolay temizlenebilmesi ve hijyenik olabilmesi için parlak ve pürüzsüzdür.
- 4 Ekstra güçlendirilmiş köşe yapısına sahiptir.
- 5 53 lt - 63 lt arasında taşıma kapasitesine sahiptir.
- 6 Hafif gövde yapısı sayesinde taşıma kolaylığı sağlar.
- 7 Üst üste dizilebilir.
- 8 Çift cidarlıdır. Cidarlar arasında poliüretan köpük kullanılmıştır.
- 9 İnsan sağlığına zararlı madde içermemektedir.
- 10 Talebe göre renk seçenekleriyle üretilebilir.

PRODUCT FEATURES

- 1 Only the trunk is dishwasher safe
- 2 Can withstand temperatures from -40°C +100°C
- 3 Smooth inside surface that is hygienic and easy to clean
- 4 Features tough reinforced corners
- 5 Can carry from 53 to 63 lt
- 6 Light case that is easy to lift
- 7 Stackable
- 8 Double walls filled with polyurethane foam
- 9 Does not contain any substances harmful to human health
- 10 Other colors available upon request

Güç / Power	1000 W
Güç Kaynağı / Power Source	220-230 V
Min. Sıcaklık / Min. Temp.	65°C
Maks. Sıcaklık / Max. Temp.	90°C
Maks. Sıcaklığa Ulaşma / Reaching Max. Temp.	4 dk./mins.
Net Ağırlık / Net Weight	17,5 Kg
İç Ölçüler / Internal Dimensions	33 x 52 x 50 cm
Dış Ölçüler / External Dimensions	44 x 73 x 63 cm

# THERMOCASE

plast|port<sup>®</sup>  
by **KAPP**

62

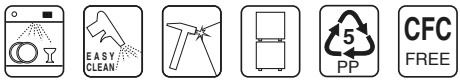



## Thermocase<sup>®</sup> P600M

» Thermobox 600 Menteseli  
Thermobox 600 (Side-Hinged)

Kod Code	Koli/Adet Pcs/Ctn
46011600	1

63



## Thermocase<sup>®</sup> P600

» Thermobox 600  
Thermobox 600

Kod Code	Koli/Adet Pcs/Ctn
46010600	1

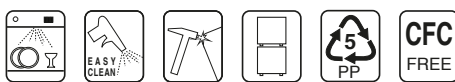

 \*Renk Seçenekleri  
\*Colour options





\* Önden yüklemeli model. Max. GN 1/1 küvet kullanımına uygundur.  
\* Front loading model. Designed for GN Food Pan Standards.

### GN 1/1 YÜKLEME SEÇENEKLERİ / GN 1/1 TRAY LOADING OPTIONS

64

<b>54 lt</b> GN 1/1 *65 GN 1/1 *65 GN 1/1 *65 GN 1/1 *65 GN 1/1 *65 GN 1/1 *65 245 Porsiyon 245 Portions	<b>57 lt</b> GN 1/1 *65 GN 1/1 *65 GN 1/1 *65 GN 1/1 *65 GN 1/1 *150 260 Porsiyon 260 Portions	<b>53 lt</b> GN 1/1 *65 GN 1/1 *65 GN 1/1 *100 GN 1/1 *150 240 Porsiyon 240 Portions	<b>58 lt</b> GN 1/1 *65 GN 1/1 *100 GN 1/1 *100 GN 1/1 *150 265 Porsiyon 265 Portions
<b>56 lt</b> GN 1/1 *100 GN 1/1 *100 GN 1/1 *100 GN 1/1 *100 255 Porsiyon 255 Portions	<b>53 lt</b> GN 1/1 *100 GN 1/1 *100 GN 1/1 *200 240 Porsiyon 240 Portions	<b>63 lt</b> GN 1/1 *100 GN 1/1 *150 GN 1/1 *200 290 Porsiyon 290 Portions	<b>56 lt</b> GN 1/1 *200 GN 1/1 *200 255 Porsiyon 255 Portions

### ÜRÜN ÖZELLİKLERİ

- 1 Bulaşık makinasında yıkanabilir.
- 2 +100°C sığağa, -40°C soğuga dayanıklıdır.
- 3 Ürün iç yüzeyinin kolay temizlenebilmesi ve hijyenik olabilmesi için parlak ve pürüzsüzdür.
- 4 Ekstra güçlendirilmiş köşe yapısına sahiptir.
- 5 53 lt - 63 lt arasında taşıma kapasitesine sahiptir.
- 6 Hafif gövde yapısı sayesinde taşıma kolaylığı sağlar.
- 7 Üst üste dizilebilir.
- 8 Çift cidarlıdır. Cidarlar arasında poliüretan köpük kullanılmıştır.
- 9 İnsan sağlığına zararlı madde içermemektedir.
- 10 Talebe göre renk seçenekleriyle üretilebilir.

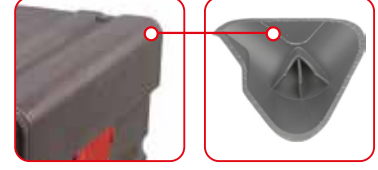

Ekstra güçlendirilmiş köşe yapısı  
Extra Reinforced Edges

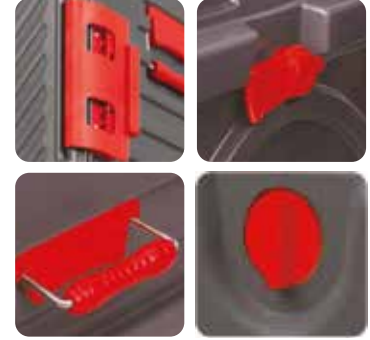

### PRODUCT FEATURES

- 1 Dishwasher safe
- 2 Can withstand temperatures from -40°C +100°C
- 3 Smooth inside surface that is hygienic and easy to clean
- 4 Features tough reinforced corners
- 5 Can carry from 53 to 63 lt
- 6 Light case that is easy to lift
- 7 Stackable
- 8 Double walls filled with polyurethane foam
- 9 Does not contain any substances harmful to human health
- 10 Other colors available upon request

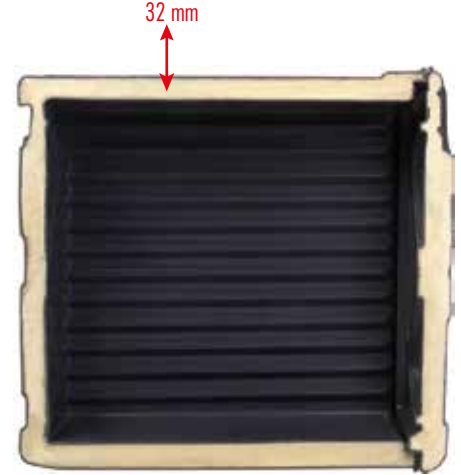

65

### ÖLÇÜLER / DIMENSIONS P600

İç Ölçüler / Internal Dimensions	33x52x50 cm
Dış Ölçüler / External Dimensions	44x66x63 cm
Ağırlık / Weight	13.5 kg

### ÖLÇÜLER / DIMENSIONS P600M

İç Ölçüler / Internal Dimensions	33x52x50 cm
Dış Ölçüler / External Dimensions	44x66x63 cm
Ağırlık / Weight	14 kg

### TESTLER / TESTS

4 adet 10 cm derinlikte küvetlerde 88°C lik sıcak su ve 0,5 °C lik soğuk su ile test edilmiştir.  
Tested with four deep trays filled with hot water at 88 °C and cold water 0,5 °C

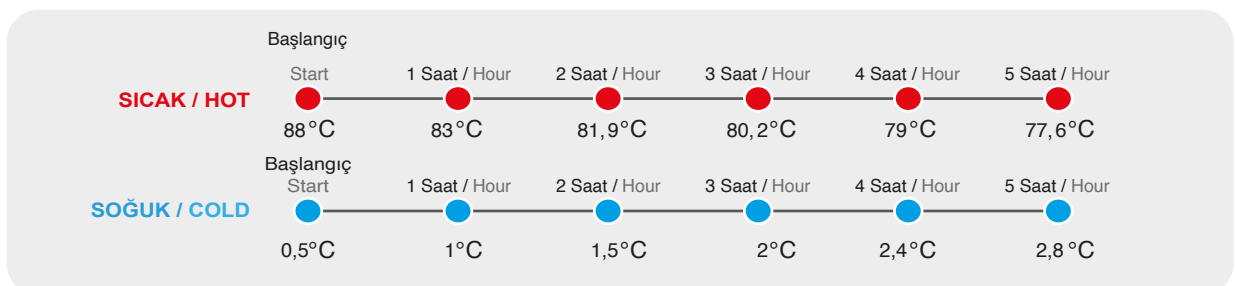

- Çift amaçlı iç hazne; yüksek kapasiteli süzgeç / sebze kurutucu
  - Kaymaz çevirme kolu
  - Ayrılabilir kapak ile kolay temizleme
  - Kullanım esnasında stabil gövde sağlayan tasarım
  - Transparan kapak
  - Fazla suyu boşaltma kolaylığı sağlayan gider bölmesi
- *Dual purposed inner basket; high capacity colander / salad spinner*
  - *Non-slip knob*
  - *Take the lid apart to make it easy to clean*
  - *Designed to remain stable during use*
  - *Transparent lid*
  - *Drain compartment that allows easy draining of excess water*



» Sebze Kurutucu  
Salad Spinner

Kod Code	Kapasite Capacity	Koli/Adet Pcs/Ctn
46700020	20 Lt	1



Gider bölgesi  
Drain compartment

67



Kapak / Cover  
■ Şeffaf / Transparent

■ Süzgeç / Filter

■ Kova / Bucket

■ Gider / Drainer

plast | port<sup>®</sup>  
by **KAPP**











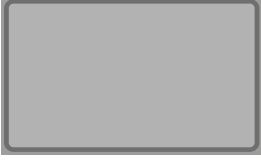

Polikarbonat Şeffaf  
Gastronorm Kvetler  
Polycarbonate GN Pans

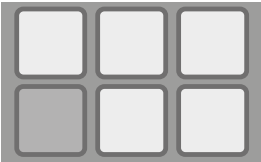
70





		Kod Code	Derinlik (mm) Depth (mm)	Koli/Adet Pcs/Ctn
	<b>1/1</b> 530x325	46011065	65	6
		46011100	100	6
		46011150	150	6
		46011200	200	6
	Kapak/ Lid	46010011		12
	<b>1/2</b> 325x265	46012065	65	12
		46012100	100	12
		46012150	150	12
		46012200	200	12
	Kapak/ Lid	46010012		12
	<b>1/3</b> 325x176	46013065	65	12
		46013100	100	12
		46013150	150	12
		Kapak/ Lid	46010013	
		<b>1/4</b> 265x162	46014065	65
46014100			100	12
46014150			150	12
Kapak/ Lid			46010014	
		<b>1/6</b> 176x162	46016065	65
	46016100		100	12
	46016150		150	12
	Kapak/ Lid		46010016	
		<b>1/9</b> 176x108	46019065	65
46019100			100	12
46019150			150	12
Kapak/ Lid			46010019	



also available

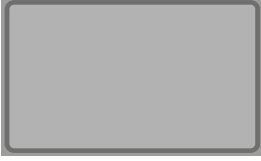

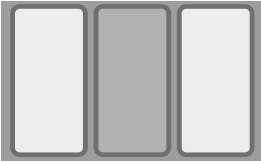
Polikarbonat Siyah  
Gastronorm K vetler  
Polycarbonate Black  
GN Pans

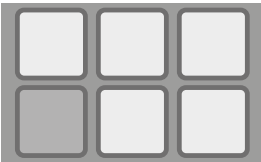
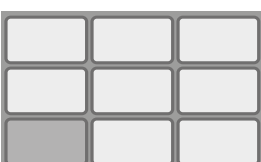
		Kod Code	Derinlik (mm) Depth (mm)	Koli/Adet Pcs/Ctn
	<b>1/1</b> 530x325	46111065	65	6
		46111100	100	6
		46111150	150	6
		46111200	200	6
	Kapak/ Lid	46010011		12
	<b>1/2</b> 325x265	46112065	65	12
		46112100	100	12
		46112150	150	12
		46112200	200	12
	Kapak/ Lid	46010012		12
	<b>1/3</b> 325x176	46113065	65	12
		46113100	100	12
		46113150	150	12
		Kapak/ Lid	46010013	
		<b>1/4</b> 265x162	46114065	65
46114100			100	12
46114150			150	12
Kapak/ Lid			46010014	
		<b>1/6</b> 176x162	46116065	65
	46116100		100	12
	46116150		150	12
	Kapak/ Lid		46010016	
		<b>1/9</b> 176x108	46119065	65
46119100			100	12
46119150			150	12
Kapak/ Lid			46010019	





also available



» Polikarbonat GN Kapak

PC GN Lid

Kod Code	Model Model	Ölçü (mm) Dim (mm)
46010011	1/1	530x325
46010012	1/2	325x265
46010013	1/3	325x176
46010014	1/4	265x162
46010016	1/6	176x162
46010019	1/9	176x108

\* Paslanmaz Çelik GN Küvetler ile uyumludur.

\* Suitable for S/S GN pans.





» PP Sızdırmaz Contalı (Paslanmaz GN Küvet uyumlu)

PP Lid w/Hermetic Seal for S/S GN Containers

Kod Code	Model Model	Ölçü (mm) Dim (mm)
-------------	----------------	-----------------------

46012011 1/1 530x325

\* GN Küvet fiyata dahil değildir.

\* GN pan is not included in price

» PC Sızdırmaz Contalı (PC GN Küvet uyumlu)

PC Lid w/Hermetic Seal for PC GN Containers

Kod Code	Model Model	Ölçü (mm) Dim (mm)
-------------	----------------	-----------------------

46011011 1/1 530x325

46011012 1/2 325x265

\* GN Küvet fiyata dahil değildir.

\* GN pan is not included in price

**POLİPROPİLEN GASTRONORM  
SAKLAMA KAPLARI**  
POLYPROPYLENE GASTRONORM  
FOOD CONTAINERS





» 1/1

1/1

Kod Code	Ölçü (mm) Dim (mm)	Koli/Adet Pcs/Ctn
46021065	1/1-65	6
46021100	1/1-100	6
46021150	1/1-150	6
46021200	1/1-200	6
46020011	Kapak/Lid	6

» 1/2

1/2

Kod Code	Ölçü (mm) Dim (mm)	Koli/Adet Pcs/Ctn
46022065	1/2-65	12
46022100	1/2-100	12
46022150	1/2-150	12
46022200	1/2-200	12
46020012	Kapak/Lid	12

» 1/3

1/3

Kod Code	Ölçü (mm) Dim (mm)	Koli/Adet Pcs/Ctn
46023065	1/3-65	12
46023100	1/3-100	12
46023150	1/3-150	12
46020013	Kapak/Lid	12

75



» 1/4

1/4

Kod Code	Ölçü (mm) Dim (mm)	Koli/Adet Pcs/Ctn
46024065	1/4-65	12
46024100	1/4-100	12
46024150	1/4-150	12
46021014	Kapak/Lid	12

» 1/6

1/6

Kod Code	Ölçü (mm) Dim (mm)	Koli/Adet Pcs/Ctn
46021665	1/6-65	12
46026100	1/6-100	12
46026150	1/6-150	12
46020016	Kapak/Lid	12

» 1/9

1/9

Kod Code	Ölçü (mm) Dim (mm)	Koli/Adet Pcs/Ctn
46029065	1/9-65	12
46029100	1/9-100	12
46029150	1/9-150	12
46020019	Kapak/Lid	12

# SELF SERVİSLER SELSERVICES



## » Standart Self Servis PC Standart Self Service PC

Kod Code	Ölçü (mm) Dim. (mm)	Model Model	Koli/Adet Pcs/Ctn
46010111	398x278x28	Standart/ Standard	20
46010118	398x278x28	ABS/ ABS	20

## » Kreş Self Servis PC Self Service PC for Kids

Kod Code	Ölçü (mm) Dim. (mm)	Model Model	Koli/Adet Pcs/Ctn
46010112	360x245x26	Kreş/ For Kids	20

76

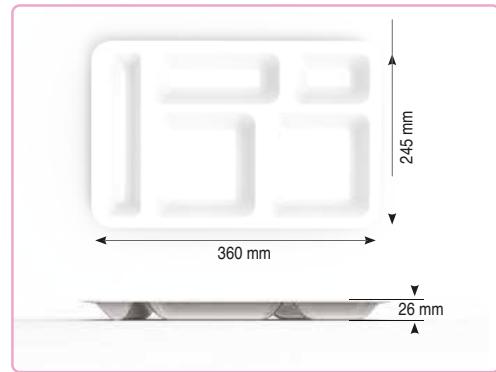
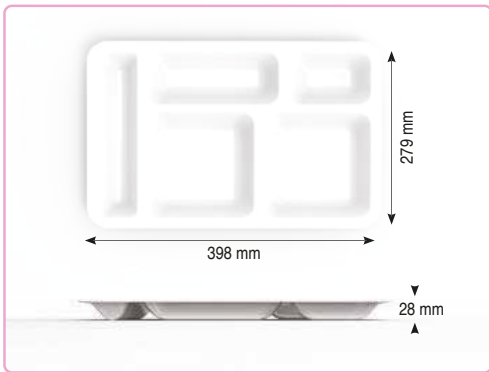

\* Adetli siparişlerde istenilen renkte üretim yapılabilir  
\* Different colors are possible after certain quantity.



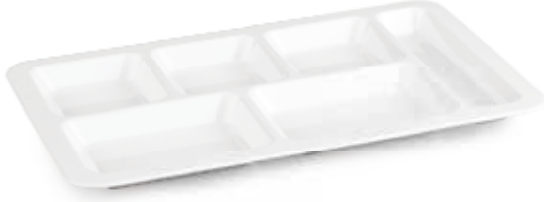

» Kahvaltılık Self Servis PC  
Self Service for Breakfast PC

Kod Code	Ölçü (mm) Dim. (mm)	Model Model	Koli/Adet Pcs/Ctn
46010113	290x180x18	Kahvaltılık Breakfast	20

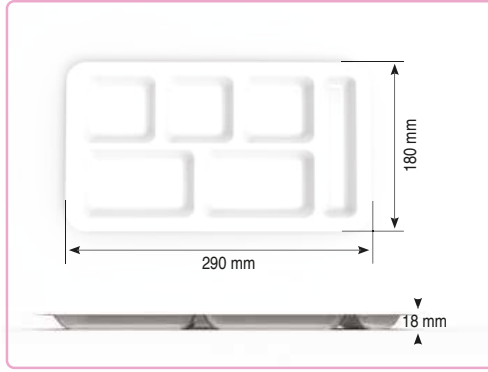

SELF SERVİS/ KAHVALTILIK / BREAKFAST



» Yumurtalıklı Kahvaltılık Self Servis PC  
Self Service for Breakfast w/Egg Part PC

Kod Code	Ölçü (mm) Dim. (mm)	Model Model	Koli/Adet Pcs/Ctn
46010114	290x180x18	Yumurtalıklı w/Egg Part	20

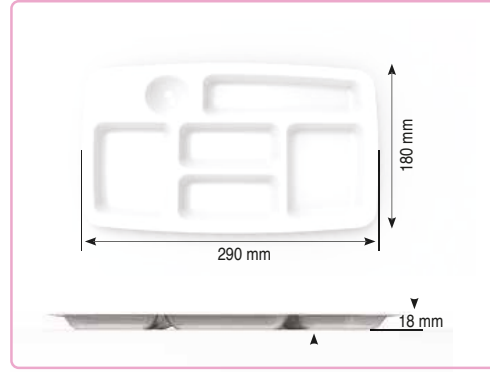

SELF SERVİS/ KAHVALTILIK YUMURTALIKLI  
SELF SERVICE/ BREAKFAST WITH EGG PART



» Hindistan Self Servis PC  
Indian Self Service PC

Kod Code	Ölçü (mm) Dim. (mm)	Model Model	Koli/Adet Pcs/Ctn
46010115	400x280x30	Hindistan Indian	20

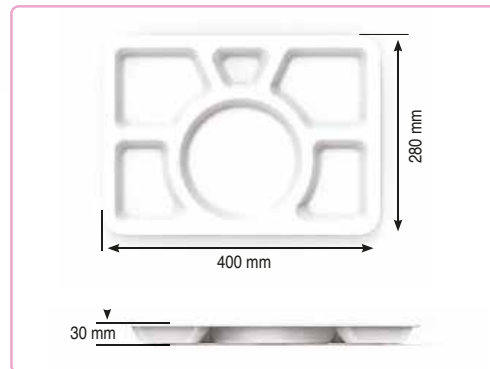

POLİKARBONAT SELF SERVİS/ HİNDİSTAN MODELİ  
POLYCARBONATE SELF SERVICE/ INDIAN MODEL

\* Adetli siparişlerde istenilen renkte üretim yapılabilir  
\* Different colors are possible after certain quantity.



# TEPSİLER

## TRAYS





» Servis Tepsisi (ABS)  
Serving Tray (ABS)

Kod Code	Ölçü (cm) Dim. (cm)	Koli/Adet Pcs/Ctn
<b>460</b> 12736	27x36	20
<b>460</b> 13244	32x44	20
<b>460</b> 13646	36x46	20
<b>460</b> 13748	37x48	20
<b>460</b> 13753	37x53	20



» Servis Tepsisi (ABS)  
Serving Tray (ABS)

Kod Code	Ölçü (cm) Dim. (cm)	Koli/Adet Pcs/Ctn
<b>461</b> 12736	27x36	20
<b>461</b> 13244	32x44	20
<b>461</b> 13646	36x46	20
<b>461</b> 13748	37x48	20
<b>461</b> 13753	37x53	20



» Servis Tepsisi (ABS)  
Serving Tray (ABS)

Kod Code	Ölçü (cm) Dim. (cm)	Koli/Adet Pcs/Ctn
<b>462</b> 12736	27x36	20
<b>462</b> 13244	32x44	20
<b>462</b> 13646	36x46	20
<b>462</b> 13748	37x48	20
<b>462</b> 13753	37x53	20



» Servis Tepsisi (ABS)  
Serving Tray (ABS)

Kod Code	Ölçü (cm) Dim. (cm)	Koli/Adet Pcs/Ctn
<b>463</b> 12736	27x36	20
<b>463</b> 13244	32x44	20
<b>463</b> 13646	36x46	20
<b>463</b> 13748	37x48	20
<b>463</b> 13753	37x53	20



» Servis Tepsisi (ABS)  
Serving Tray (ABS)

Kod Code	Ölçü (cm) Dim. (cm)	Koli/Adet Pcs/Ctn
<b>464</b> 12736	27x36	20
<b>464</b> 13244	32x44	20
<b>464</b> 13646	36x46	20
<b>464</b> 13748	37x48	20
<b>464</b> 13753	37x53	20



» Servis Tepsisi (ABS)  
Serving Tray (ABS)

Kod Code	Ölçü (cm) Dim. (cm)	Koli/Adet Pcs/Ctn
<b>465</b> 12736	27x36	20
<b>465</b> 13244	32x44	20
<b>465</b> 13646	36x46	20
<b>465</b> 13748	37x48	20
<b>465</b> 13753	37x53	20



# PC BARDAKLAR

## PC GLASSES





» Bardak

Glass

Kod Code	ml ml	Koli/Adet Pcs/Ctn
<b>460</b> 10250	250	50
<b>460</b> 10300	300	50
<b>460</b> 10400	400	50

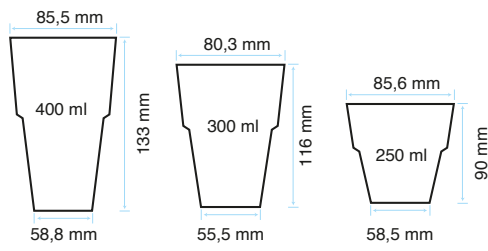

**460 461 462 463 464 465**



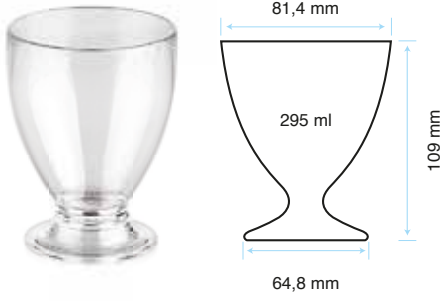

» Ayaklı Bardak  
Goblet Glass

Kod Code	ml ml	Koli/Adet Pcs/Ctn
46010295	295	50



82

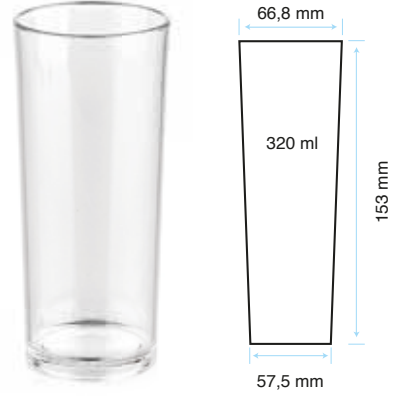

» Kokteyl Bardak  
Cocktail Glass

Kod Code	ml ml	Koli/Adet Pcs/Ctn
46010320	320	50

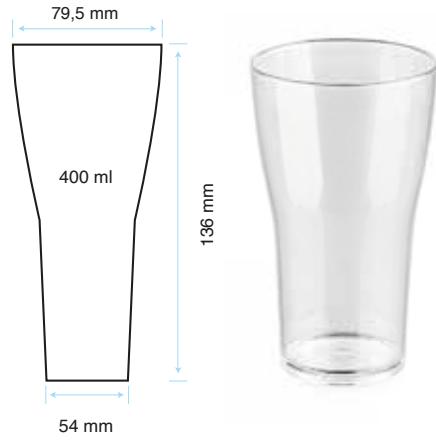

» Tulip Bardak  
Tulip Glass

Kod Code	ml ml	Koli/Adet Pcs/Ctn
46012400	400	100

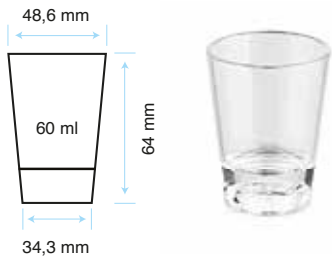

» Shot Bardak  
Shot Glass

Kod Code	ml ml	Koli/Adet Pcs/Ctn
46010060	60	245



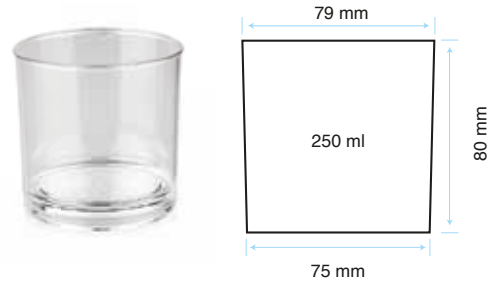

» Viski Bardağı  
Whiskey Glass

Kod Code	ml ml	Koli/Adet Pcs/Ctn
46012250	250	50

84

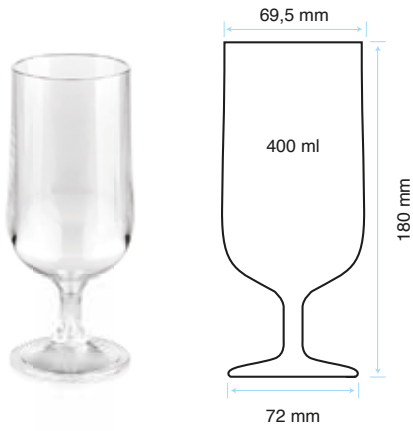

» Goblet Bardak  
Goblet Glass

Kod Code	ml ml	Koli/Adet Pcs/Ctn
46013400	400	50





» Şarap Kadehi  
Wine

Kod Code	ml ml	Koli/Adet Pcs/Ctn
46014250	250	50



85

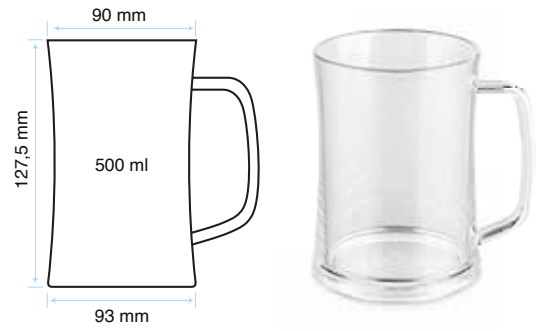

» Ayran-Bira Bardak  
Beer Glass

Kod Code	ml ml	Koli/Adet Pcs/Ctn
46010500	500	24



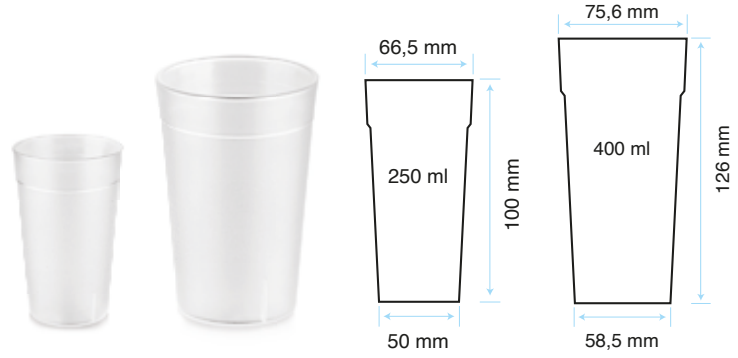

» Kumlu Bardak  
Sandy Surface Glass

Kod Code	ml ml	Koli/Adet Pcs/Ctn
46011250	250	200
46011400	400	250

86

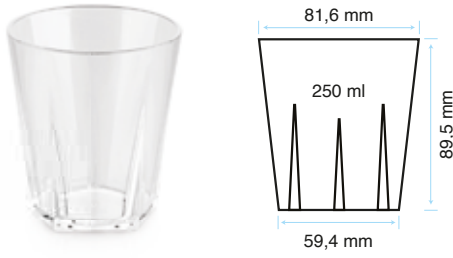

» Prizma Bardak  
Prisma Glass

Kod Code	ml ml	Koli/Adet Pcs/Ctn
46013250	250	50

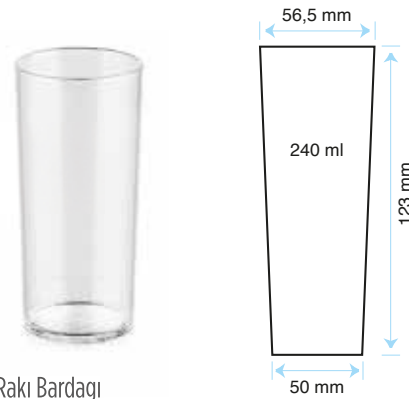

» Rakı Bardađı  
Juice Glass

Kod Code	ml ml	Koli/Adet Pcs/Ctn
46010240	240	50



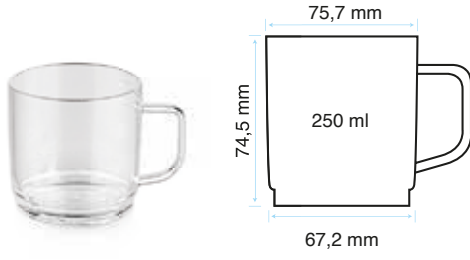

» Çay-Kahve Kupası

Mug

Kod Code	ml ml	Koli/Adet Pcs/Ctn
46015250	250	50

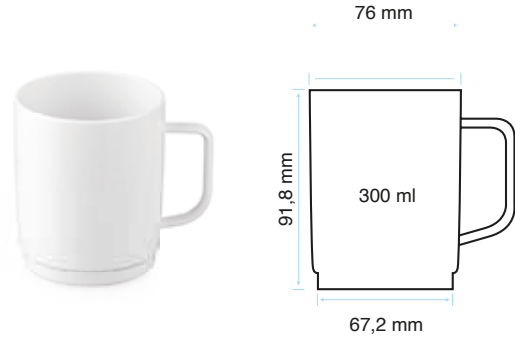

» Çay-Kahve Kupası

Mug

Kod Code	ml ml	Koli/Adet Pcs/Ctn
46015300	300	50



87



» Kahve Kupası

Mug

Kod Code	ml ml	Koli/Adet Pcs/Ctn
46010280	280	24

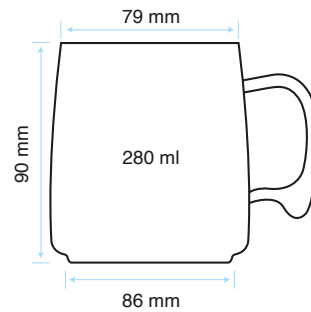

\* Adet sağlanırsa tüm bardaklara logo baskısı yapılabilir.

\* Logo printing is possible for certain MOQ





# BASKETLER DISHWASHER RACKS

plast|port<sup>®</sup>

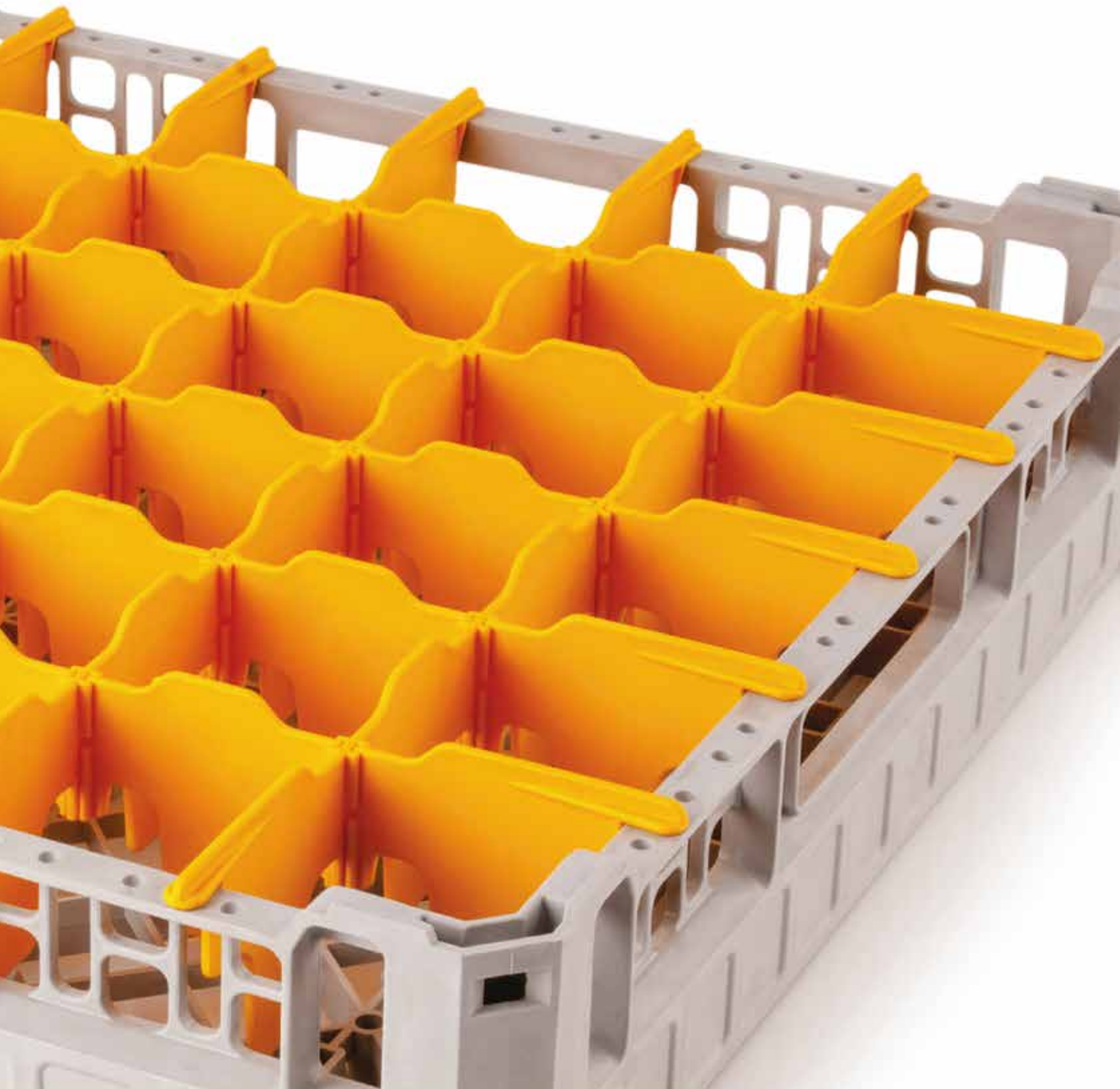

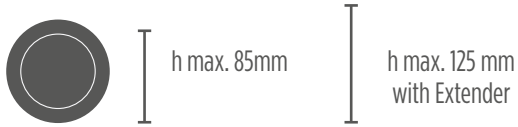
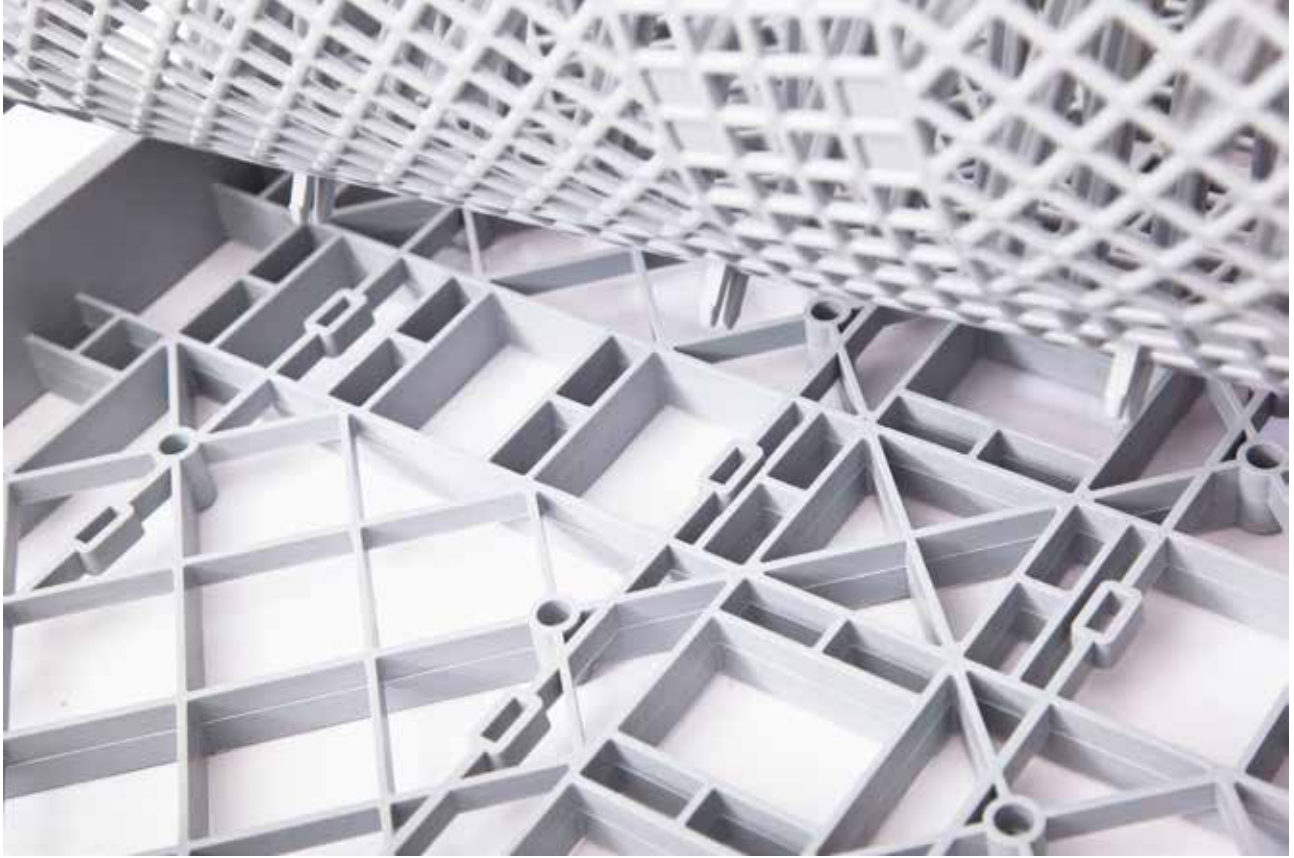

» Tabak Basketi  
Plate/Trays Rack

Kod Code	Ölçü (mm) Dim. (mm)	Koli/Adet Pcs/Ctn
43030001	500x500x100	6



» Çatal Kaşık Basketi  
Cutlery Rack

Kod Code	Ölçü (mm) Dim. (mm)	Koli/Adet Pcs/Ctn
43030002	500x500x100	6

## Basketler / Dishwasher Racks

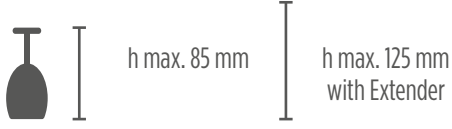

» Düz Bardak Basketi  
Glass Rack

Kod Code	Ölçü (mm) Dim. (mm)	Koli/Adet Pcs/Ctn
43030003	500x500x100	6



» Yükseltici Açık Bölmesiz  
Open Extender

Kod Code	Ölçü (mm) Dim. (mm)	Koli/Adet Pcs/Ctn
43004006	500x500x40	10

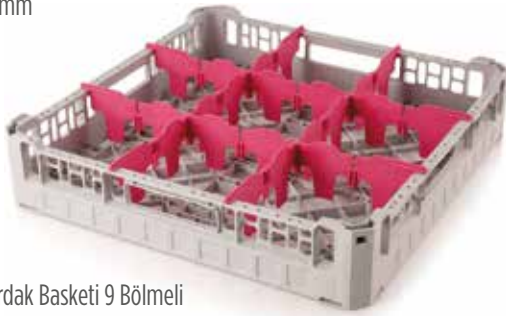

» Bardak Basketi 9 Bölmeli  
9 Compartment Base

Kod Code	Ölçü (mm) Dim. (mm)	Koli/Adet Pcs/Ctn
43003009	500x500x100	6



» Yükseltici 9 Bölmeli  
9 Compartment Extender

Kod Code	Ölçü (mm) Dim. (mm)	Koli/Adet Pcs/Ctn
43004001	500x500x40	10



» Bardak Basketi 16 Bölmeli  
16 Compartment Base

Kod Code	Ölçü (mm) Dim. (mm)	Koli/Adet Pcs/Ctn
43003016	500x500x100	6



» Yükseltici 16 Bölmeli  
16 Compartment Extender

Kod Code	Ölçü (mm) Dim. (mm)	Koli/Adet Pcs/Ctn
43004002	500x500x40	10

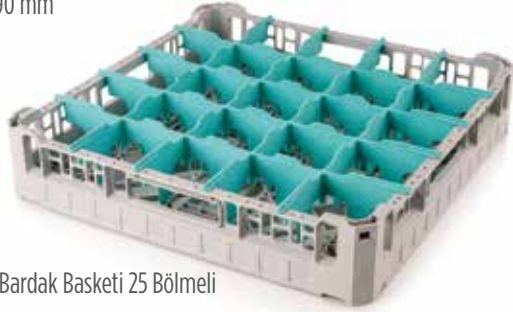

» Bardak Basketi 25 Bölmeli  
25 Compartment Base

Kod Code	Ölçü (mm) Dim. (mm)	Koli/Adet Pcs/Ctn
43003025	500x500x100	6



» Yükseltici 25 Bölmeli  
25 Compartment Extender

Kod Code	Ölçü (mm) Dim. (mm)	Koli/Adet Pcs/Ctn
43004003	500x500x40	10



» Bardak Basketi 36 Bölmeli  
36 Compartment Base

Kod Code	Ölçü (mm) Dim. (mm)	Koli/Adet Pcs/Ctn
43003036	500x500x100	6



» Yükseltici 36 Bölmeli  
36 Compartment Extender

Kod Code	Ölçü (mm) Dim. (mm)	Koli/Adet Pcs/Ctn
43004004	500x500x40	10

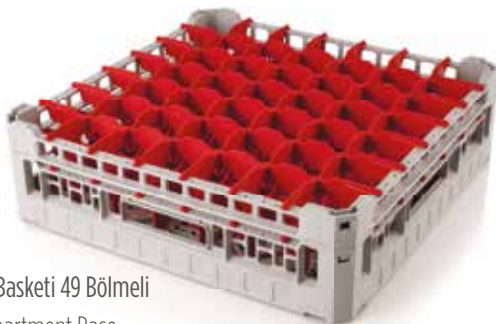

» Bardak Basketi 49 Bölmeli  
49 Compartment Base

Kod Code	Ölçü (mm) Dim. (mm)	Koli/Adet Pcs/Ctn
43003049	500x500x100	6



» Yükseltici 49 Bölmeli  
49 Compartment Extender

Kod Code	Ölçü (mm) Dim. (mm)	Koli/Adet Pcs/Ctn
43004005	500x500x40	10



Gövdeden ayrı paketlenen iç seperatörler nakliye esansında avantaj sağlar  
Internal separators can be packaged separately, providing an advantage during transportation

Gövdeden ayrı stoklanabilen seperatörler farklı ürün çeşitlerini stoklamayı kolaylaştırır  
Internal separators separate from the body, provides easy storage for different models

92



Kolay takılabilir kilit mekanizması  
Easy locking mechanism

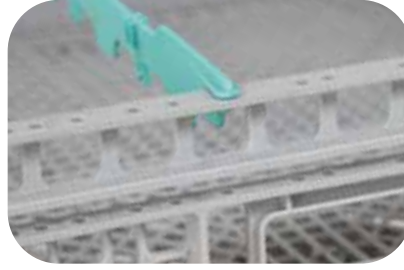

Ekstra sağlam kilit mekanizması sayesinde kilitlenen seperatörler takıldıktan sonra tekrar çıkarılamaz  
Separators that locked after installation cannot be removed again thanks to its extra strong locking mechanism

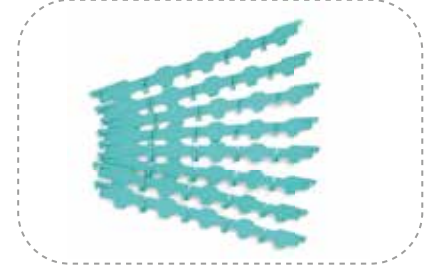

İnce yapraklar halinde paketlenen seperatörler stoklama halinde yerden tasarruf sağlar  
Separators packaged in thin sheets, gives easy storage

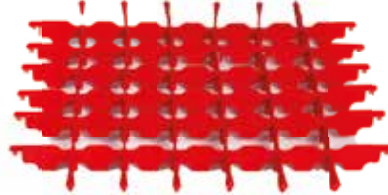

Müşterinin istediği modele göre kolayca birleştirilip kullanıma hazır hale getirilir

It can be easily combined according to the model which desired by the customer



Kolayca takılabilen yükseltici kilit mekanizması  
Easy extender locking mechanism



Yükselticiler üzerindeki ekstra kilit mekanizması  
takıldıktan sonra çıkma riskini ortadan kaldırır  
Extra locking mechanism on extenders  
eliminates the risk of detachment after insertion

Kolayca takılabilen yükselticiler sayesinde  
istenilen yüksekliğe kadar basket yüksekliği ayarlanabilir.

Thanks to the easily attachable extenders,  
the height of the basket can be adjusted to the desired height.

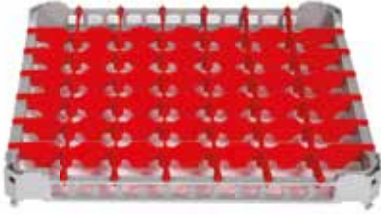

Yükseltici / Extender



Basket / Base



İlk kat / First level



İkinci kat / Second level



Üçüncü kat / Third level

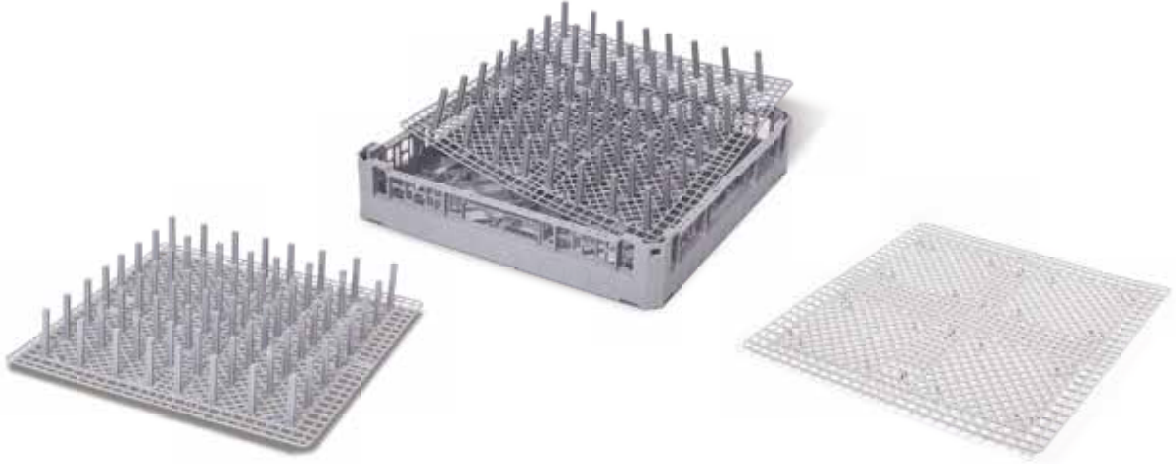

» Tabak Basketi Aparatı  
Plate/Tray Rack Separator

Kod Code	Ölçü (mm) Dim. (mm)	Koli/Adet Pcs/Ctn
43130001	500x500x100	6

» Çatal Bıçak Basketi Aparatı  
Cutlery Rack Separator

Kod Code	Ölçü (mm) Dim. (mm)	Koli/Adet Pcs/Ctn
43130002	500x500x10	10



» Bardak Basketi Aparatı 9 Bölmeli  
9 Compartment Base Separator

Kod Code	Ölçü (mm) Dim. (mm)	Koli/Adet Pcs/Ctn
43003010	500x500x100	18



» Yükseltici Aparatı 9 Bölmeli  
9 Compartment Extender Separator

Kod Code	Ölçü (mm) Dim. (mm)	Koli/Adet Pcs/Ctn
43004011	500x500x40	24



» Bardak Basketi Aparatı 16 Bölmeli  
16 Compartment Base Separator

Kod Code	Ölçü (mm) Dim. (mm)	Koli/Adet Pcs/Ctn
43003017	500x500x100	18

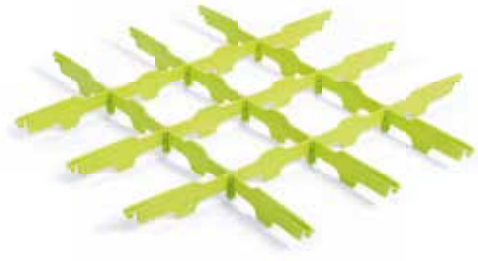

» Yükseltici Aparatı 16 Bölmeli  
16 Compartment Extender Separator

Kod Code	Ölçü (mm) Dim. (mm)	Koli/Adet Pcs/Ctn
43004012	500x500x40	18



» Bardak Basketi Aparatı 25 Bölmeli  
25 Compartment Base Separator

Kod Code	Ölçü (mm) Dim. (mm)	Koli/Adet Pcs/Ctn
43004013	500x500x100	18



» Yükseltici Aparatı 25 Bölmeli  
25 Compartment Extender Separator

Kod Code	Ölçü (mm) Dim. (mm)	Koli/Adet Pcs/Ctn
43004016	500x500x40	24

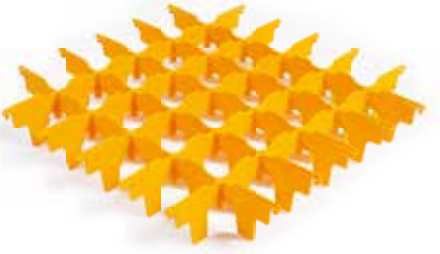

» Bardak Basketi Aparatı 36 Bölmeli  
36 Compartment Base Extender

Kod Code	Ölçü (mm) Dim. (mm)	Koli/Adet Pcs/Ctn
43004014	500x500x100	18

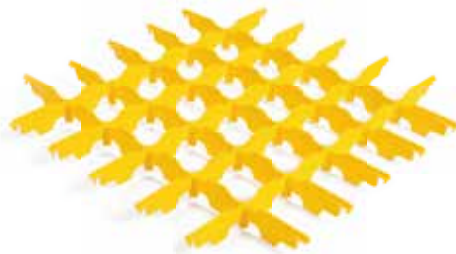

» Yükseltici Aparatı 36 Bölmeli  
36 Compartment Extender Separator

Kod Code	Ölçü (mm) Dim. (mm)	Koli/Adet Pcs/Ctn
43004017	500x500x40	18



» Bardak Basketi Aparatı 49 Bölmeli  
49 Compartment Base Separator

Kod Code	Ölçü (mm) Dim. (mm)	Koli/Adet Pcs/Ctn
43004015	500x500x100	18



» Yükseltici Aparatı 49 Bölmeli  
49 Compartment Extender Separator

Kod Code	Ölçü (mm) Dim. (mm)	Koli/Adet Pcs/Ctn
43004018	500x500x40	24





» Servis Arabası (Açık)  
Serving Trolley

Kod Code	Ölçü (cm) Dim. (cm)	Koli/Adet Pcs/Ctn
46010028	107x52x96	1

\* Kovalar fiyata dahil değildir.  
\* Kovalar fiyata dahil değildir.



» Servis Arabası (Kapalı)  
Serving Trolley (Closed)

Kod Code	Ölçü (cm) Dim. (cm)	Koli/Adet Pcs/Ctn
46010027	98x53x93	1



» Servis Arabası Kahverengi (Açık)  
Serving Trolley Brown

Kod Code	Ölçü (cm) Dim. (cm)	Koli/Adet Pcs/Ctn
46110028	107x52x96	1

\* Kovalar fiyata dahil değildir.  
\* Kovalar fiyata dahil değildir.



» Servis Arabası Kahverengi (Kapalı)  
Serving Trolley Brown (Closed)

Kod Code	Ölçü (cm) Dim. (cm)	Koli/Adet Pcs/Ctn
46110027	98x53x93	1



» 5 Katlı Açık Servis Rafı  
Serving Trolley 5 Shelved

Kod Code	Ölçü (cm) Dim. (cm)	Koli/Adet Pcs/Ctn
46011029	160x80x50	1



» 5 Katlı Kapalı Servis Rafı  
Serving Trolley 5 Shelved (Closed)

Kod Code	Ölçü (cm) Dim. (cm)	Koli/Adet Pcs/Ctn
46011030	160x80x50	1



» Çöp Kovası  
Waste Bin

Kod Code	Ölçü (cm) Dim. (cm)	Koli/Adet Pcs/Ctn
43010011	33,5x23x44,5	2





» Erzak Arabası  
Ingredient Bin w/Sliding Lid

Kod Code	Ölçü (cm) Dim. (cm)	Lt Lt	Koli/Adet Pcs/Ctn
46010062	72,4x35x56,5	62	1
46010082	72,4x35x69,6	82	1
46010010	75x39x76	102	1

98 » PP Pizza Hamur Teknesi  
PP Dough Tray

Kod Code	Ölçü (mm) Dim (mm)	Lt Lt	Koli/Adet Pcs/Ctn
46010026	400x600x77	16,8	8



» Ketçap Dispenseri  
Ketchup Dispenser

Kod Code	Lt Lt	Koli/Adet Pcs/Ctn
46010022	2	1



» Mayonez Dispenseri  
Mayonnaise Dispenser

Kod Code	Lt Lt	Koli/Adet Pcs/Ctn
46010023	2	1



» Hardal Dispenseri  
Mustard Dispenser

Kod Code	Lt Lt	Koli/Adet Pcs/Ctn
46010025	2	1



» PC Düz Tabak  
PC Flat Plate

Kod Code	Ø (cm) Ø (cm)	Koli/Adet Pcs/Ctn
46040013	13	100
46040015	15	100
46040017	17	108
46040019	19	108
46040021	21	108
46040023	23	72
46040025	25	72
46040028	28	72



» PC Çukur Tabak  
PC Soup Plate

Kod Code	Ø (cm) Ø (cm)	Koli/Adet Pcs/Ctn
46030019	19	72
46030021	21	72



» PC Oluklu Tabak  
PC Ribbed Plate

Kod Code	Ø (cm) Ø (cm)	Koli/Adet Pcs/Ctn
46050017	17	72
46050018	18,5	72



» PC Pizza Tabağı  
PC Pizza Plate

Kod Code	Ø (cm) Ø (cm)	Koli/Adet Pcs/Ctn
46050032	32	24



» PC Kare Kayık Tabak  
PC Appetizer Plate

Kod Code	Ölçü (cm) Dim. (cm)	Koli/Adet Pcs/Ctn
46020210	12	108
46020014	14	108
46020017	17	108
46020020	20	108



» PC Kayık Tabak  
PC Shallow Platter

Kod Code	Ø (cm) Ø (cm)	Koli/Adet Pcs/Ctn
46011114	14	108
46010024	24	72
46010029	29	48
46010034	34	24



» PC Çorba Kasesi & Kapak  
PC Bowl & Cover

Kod Code	Model Model	Ø (cm) Ø (cm)	Koli/Adet Pcs/Ctn
46050012	Kase/Bowl	12	108
46150067	Kapak/Cover	12	108



» PC Tabak Kapağı  
PC Plate Cover

Kod Code	Ölçü (cm) Dim. (cm)	Koli/Adet Pcs/Ctn
46050023	23,5	72



» PC Kayık Tabak Kapağı  
PC Appetizer Plate Cover

Kod Code	Ø (cm) Ø (cm)	Koli/Adet Pcs/Ctn
46010224	24	72



» Petunia Sosluk/Reçellik  
Petunia PC Sauce Cup

Kod Code	Kapasite (ml) Capacity (ml)	Koli/Adet Pcs/Ctn
46010040	40	160
46010055	55	160

460 461 462 463 464  
/ / /



» Petunia Sosluk/Reçellik  
Petunia PC Sauce Cup

Kod Code	Kapasite (ml) Capacity (ml)	Koli/Adet Pcs/Ctn
46020220	220	108



» Begonia Sosluk/Reçellik  
Begonia PC Sauce Cup

Kod Code	Kapasite (ml) Capacity (ml)	Koli/Adet Pcs/Ctn
46010030	30	96
46011060	60	96

460 461 462 465 464  
/ / /



» Polikarbonat Tuzluk&Biberlik  
PC Salt & Pepper

Kod Code	Model Model	Koli/Adet Pcs/Ctn
46010070	Tuzluk / Salt Sprinkler	40
46010071	Karabiberlik / Pepper Sprinkler	40
46010074	Kürdanlıklı Set/ Set w/Toothpick	48



» PC Şekerlik / Baharatlık  
PC Sugar Bowl/ Cruet

Kod Code	Model Model	Ölçü (mm) Dim. (mm)	Koli/Adet Pcs/Ctn
46010004	Şekerlik / Sugar Bowl	12x8	6
46010006	Baharatlık / Cruet	68x57	6



» PC Servis Kaşığı  
PC Serving Spoon

Kod Code	Koli/Adet Pcs/Ctn
46010007	50



» PC Delikli Servis Kaşığı  
PC Perforated Serving Spoon

Kod Code	Koli/Adet Pcs/Ctn
46010008	50



» PC Servis Maşa  
PC Serving Tong

Kod Code	Koli/Adet Pcs/Ctn
46010021	15



» PC Makarna Maşa  
PC Pasta Tong

Kod Code	Koli/Adet Pcs/Ctn
46010018	15



» PC Sos Kepçe  
PC Sauce Ladle

Kod Code	Ölçü (cm) Dim. (cm)	Koli/Adet Pcs/Ctn
46010009	20	25
46010015	24	25



» PC Şaşula  
PC Scoop

Kod Code	Model Model	Koli/Adet Pcs/Ctn
46010116	Düz/Plain	24
46010117	Delikli/Perforated	24



» Rotil Ayak  
Rotil Feet

Kod Code	Ölçü(cm) Dim.(cm)	Koli/Adet Pcs/Ctn
46014055	40x55x115/181	200



» Rotil Ayak  
Rotil Feet

Kod Code	Ölçü(cm) Dim.(cm)	Koli/Adet Pcs/Ctn
46014040	40x40x93/151	250



» Rotil Ayak  
Rotil Feet

Kod Code	Ölçü(cm) Dim.(cm)	Koli/Adet Pcs/Ctn
46016060	Ø 60	100



# SERTİFİKALAR CERTIFICATIONS





Kapp Mutfak ve Madeni Eşya  
San. Tic. Ltd. Şti.  
Yazıbaşı Mah. Kuşçu Cad. No: 11/1  
35875 Yazıbaşı, Torbalı / İzmir Türkiye  
Tel. +90 232 853 74 74 (Pbx)  
Fax. +90 232 853 74 75  
kapp@kapp.com.tr  
www.kapp.com.tr  
www.kapponline.com.tr

plast | port  
by KAPP

Plastport Plastik Sanayi ve Ticaret  
Anonim Şti.  
Yazıbaşı Mah. Kuşçu Cad. No: 11/1  
35875 Yazıbaşı, Torbalı / İzmir Türkiye  
Tel. +90 232 853 74 74 (Pbx)  
Fax. +90 232 853 74 75  
info@plastport.com.tr  
www.plastport.com.tr